

Invacare® Action 2 NG

en **Manual Wheelchair
User Manual**

This manual **MUST** be given to the operator of the product.

BEFORE using this product, this manual **MUST** be read and saved for future reference.



Yes, you can.

Contents

1 General	4		
1.1 Introduction	4		
1.2 Symbols in this Document	4		
1.2.1 Other Symbols	5		
1.3 Warranty Information	5		
1.4 Limitation of Liability	5		
1.5 Compliance	5		
1.5.1 Product-specific standards	5		
1.6 Service Life	6		
2 Safety	7		
2.1 Safety Information	7		
2.2 Safety Devices	10		
2.3 Labels and symbols on the product	10		
3 Product Overview	12		
3.1 Product Description	12		
3.2 Intended use	12		
3.3 Main parts of the wheelchair	13		
3.4 Parking brakes	13		
3.5 Backrest	14		
3.5.1 Standard Backrest Cover	15		
3.5.2 Backrest cover height	15		
3.5.3 Fixed backrest	15		
3.5.4 Folding backrest	15		
3.5.5 Reclining Backrest	16		
3.6 Backbrace for the backrest	17		
3.7 Push handles	18		
3.8 Armrests	19		
3.8.1 Armrest, stepless height adjustable, removable	19		
3.8.2 Armrest, foldable and removable	20		
3.9 Leg rests	20		
3.9.1 Swing away leg rests	21		
3.9.2 Swing away, Angle Adjustable Leg Rests	21		
3.10 Anti-tip device	22		
3.11 Seat Cushion	24		
4 Options	25		
4.1 Transit Lite version	25		
4.2 Posture Belt	28		
4.3 Headrest	30		
4.4 Tipper aid	31		
4.5 Table tray	31		
4.6 Drip stand	32		
4.7 Passive illumination	32		
4.8 Cane holder	33		
5 Setup	34		
5.1 Safety Information	34		
5.2 Delivery Check	34		

© 2024Invacare Corporation

All rights reserved. Republication, duplication or modification in whole or in part is prohibited without prior written permission from Invacare. Trademarks are identified by ™ and ®. All trademarks are owned by or licensed to Invacare Corporation or its subsidiaries unless otherwise noted.

Making Life's Experiences Possible is a registered trademark in the U.S.A.

6	Using the wheelchair	35	11	Technical data	58
6.1	Safety Information	35	11.1	Dimensions and weight	58
6.2	Braking during use	35	11.2	Maximum Weight of Removable Parts	60
6.3	Move to/from the wheelchair	36	11.3	Tyres	61
6.4	Driving and Steering the Wheelchair	37	11.4	Materials	61
6.5	Negotiating steps and kerbs	38	11.5	Environmental conditions	62
6.6	Going up and down stairs	40			
6.7	Negotiating Ramps and Slopes	40			
6.8	Stability and balance when seated	41			
7	Transport	43			
7.1	Safety Information	43			
7.2	Folding and unfolding the wheelchair	43			
7.3	Lifting the wheelchair	44			
7.4	Removing and fitting the rear wheels	44			
7.5	Transporting the Manual Wheelchair without Occupant	45			
7.6	Transporting the Occupied Wheelchair in a Vehicle	45			
8	Maintenance	51			
8.1	Safety Information	51			
8.2	Maintenance schedule	51			
8.3	Cleaning and disinfection	53			
8.3.1	General Safety Information	53			
8.3.2	Cleaning Intervals	54			
8.3.3	Disinfection	54			
9	Troubleshooting	55			
9.1	Safety Information	55			
9.2	Identifying and repairing faults	55			
10	After use	57			
10.1	Storage	57			
10.2	Disposal	57			
10.3	Reconditioning	57			

1 General

1.1 Introduction

This user manual contains important information about the handling of the product. To ensure safety when using the product, read the user manual carefully and follow the safety instructions.

Only use this product if you have read and understood this manual. Seek additional advice from a healthcare professional who is familiar with your medical condition and clarify any questions regarding the correct use and necessary adjustment with the healthcare professional.

Note that there may be sections in this document, which are not relevant to your product, since this document applies to all available models (on the date of printing). If not otherwise stated, each section in this document refers to all models of the product.

The models and configurations available in your country can be found in the country-specific sales documents. Invacare reserves the right to alter product specifications without further notice.

Previous product versions may not be described in this manual's current revision. If you require assistance, please contact Invacare.

Before reading this document, make sure you have the latest version. You find the latest version as a PDF on the

Invacare website.

If you find that the font size in the printed document is difficult to read, you can download the PDF version from the website. The PDF can then be scaled on screen to a font size that is more comfortable for you.

For more information about the product, for example product safety notices and product recalls, contact your Invacare distributor. See addresses at the end of this document. In case of a serious incident with the product, you should inform the manufacturer and the competent authority in your country.

1.2 Symbols in this Document

Symbols and signal words are used in this document and apply to hazards or unsafe practices which could result in personal injury or property damage. See the information below for definitions of the signal words.



WARNING

Indicates a hazardous situation that could result in serious injury or death if it is not avoided.



CAUTION

Indicates a hazardous situation that could result in minor or slight injury if it is not avoided.



NOTICE

Indicates a hazardous situation that could result in damage to property if it is not avoided.



Tips and Recommendations

Gives useful tips, recommendations and information for efficient, trouble-free use.

1.2.1 Other Symbols

(Not applicable for all manuals)



UK Responsible Person

Indicates if a product is not manufactured in the UK.



Triman

Indicates recycling and sorting rules (only relevant for France).

1.3 Warranty Information

We provide a manufacturer's warranty for the product in accordance with our General Terms and Condition of Business in the respective countries.

Warranty claims can only be made through the provider from whom the product was obtained

1.4 Limitation of Liability

Invacare accepts no liability for damage arising from:

- Non-compliance with the user manual
- Incorrect use
- Natural wear and tear

- Incorrect assembly or set-up by the purchaser or a third party
- Technical modifications
- Unauthorised modifications and/or use of unsuitable spare parts

1.5 Compliance

Quality is fundamental to the company's operation, working within the disciplines of ISO 13485. This product features the CE mark, in compliance with the Medical Device Regulation 2017/745 Class I.

This product features the UKCA mark, in compliance with Part II UK MDR 2002 (as amended) Class I.

We are continuously working towards ensuring that the company's impact on the environment, locally and globally, is reduced to a minimum.

We only use REACH compliant materials and components.

1.5.1 Product-specific standards

The wheelchair has been tested in accordance with EN 12183. It includes testing for flammability. For further information about local standards and regulations, contact your local Invacare representative. See addresses at the end of this document.

1.6 Service Life

The expected service life of this product is five years when used daily and in accordance with the safety instructions, maintenance intervals and correct use, stated in this manual. The effective service life can vary according to frequency and intensity of use.

2 Safety

2.1 Safety Information

This section contains important safety information for the protection of the wheelchair occupant and assistant and for safe, trouble-free use of the wheelchair.

**WARNING!****Risk of accidents and serious injury**

Accidents with resulting serious injury can occur if the wheelchair is improperly adjusted.

- Contact your wheelchair provider in order to a qualified technician does the adjustments needed.



The Invacare expects that the qualified technician is familiar with the product, with good technical knowledge to understand and follow the steps of the described instructions in this manual and equipped with proper tools.

**WARNING!****Risk of overturning**

The longitudinal position of the rear wheels axis of the wheelchair compared to the backrest position can affect its stability.

- A forwards position makes the wheelchair less stable and increase the risk of tipping backwards, but improves its manoeuvrability by a better grip position of the handrim and a short turning radius.
- Conversely, by moving the rear wheels axis backwards, the wheelchair is more stable and tilts less easily, but its manoeuvrability is reduced.
- Depending on the occupant's abilities and its particular safety limits, the decrease in stability can be compensated for by installing an anti-tip device.

**WARNING!****Risk of tilting**

The rear wheel axle position and the angle of your wheelchair's backrest are two of the key adjustments that can affect your stability.

- The changes of rear/ front wheels position and/or angle fork adjustments must only be performed by a qualified technician after the assessment of your healthcare professional.

**WARNING!****Risk of tipping**

The hanging of additional load (back pack or similar items) onto your chair back support tubes can affect the rearward stability of your wheelchair. This can cause the chair to tip backwards causing injury.

- Try to avoid putting additional load in the back of the wheelchair.
- We strongly recommend the use of anti-tip device (available as an option) when using your back support tubes with additional load.

**WARNING!****Risk due to driving style being unsuitable for environmental the conditions**

- There is a risk of skidding on wet ground, gravel or uneven terrain.
- Always adjust your speed and driving style to the conditions (weather, surface, individual ability, etc).

**WARNING!****Risk of injury**

In a collision you could sustain injury to parts of your body that extend beyond the wheelchair (e.g. feet or hands).

- Avoid an unbraked collision.
- Never drive into an object head-on.
- Drive carefully through narrow passages.

**WARNING!****Risk due to wheelchair being out of control**

At high speed you could lose control of your wheelchair and overturn.

- Drive carefully
- Always adapt your speed and your driving style to the conditions (weather, surface, individual ability, etc.).
- Avoid collision.



CAUTION!

Risk of burning

The wheelchair components can heat up when exposed to external sources of heat.

Do not expose the wheelchair to strong sunlight before use.

Before use, check all components that come into contact with your skin for their temperature.

Before use, check all components that come into contact with your skin for their temperature.



WARNING!

Risk of death or serious injury

In case of fire or smoke, wheelchair occupants are at particular risk of death or serious injury, when they are not able to move away from the source of fire or smoke. Lighted matches, lighter and cigarettes can cause an open flame in the wheelchair surroundings or on clothes.

- Avoid using or storing the wheelchair near open flames or combustible products.
- Do not smoke while using the wheelchair.



CAUTION!

Risk of getting parts of body caught

There is always a risk of getting parts of the body e.g. fingers or arms, caught in the moving parts of the wheelchair.

- Take attention while activating and deactivating the mechanisms of moving parts, such as the removable axle of the rear wheel, folding backrest or anti-tip device.



CAUTION!

Risk of injury

- In case of pressure sore or injured skin, protect your injuries to avoid a direct contact with the fabrics of the device. Refer to a healthcare professional for medical advice.



CAUTION!

Risk of injury

When combining the wheelchair with another device, the restrictions of both devices apply for the combination. E.g. the maximum occupant mass for the device may be lower.

- Only use combinations with other devices which are allowed by Invacare. Contact your authorized provider for more information.
- Before use, read the user manual of each device and check the restrictions.

2.2 Safety Devices



WARNING!

Risk of accidents

Safety devices that are incorrectly set or no longer working (brakes, anti-tip device) can cause accidents.

- Always check that the safety devices are working before you use the wheelchair and have them checked regularly by a qualified technician.



CAUTION!

Risk of injury

Non-original or wrong parts may affect the function and safety of the product.

- Only use original parts for the product in use.
- Due to regional differences, refer to your local Invacare catalogue or website for available options or contact your Invacare distributor. See addresses at the end of this document.



The functions of the safety devices are described in 3.1 *Product Description*, page 12

2.3 Labels and symbols on the product Identification label

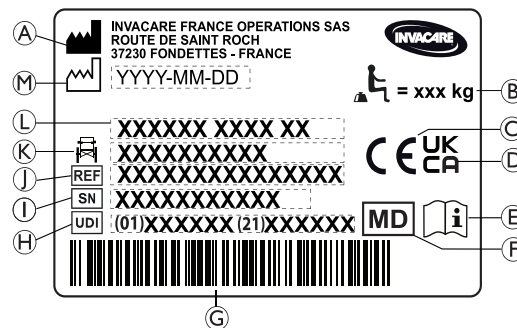
The identification label is attached to the frame of your wheelchair and gives the following information:



- Ⓐ Manufacturer's name and address
- Ⓑ Maximum load of the wheelchair
- Ⓒ European conformity mark
- Ⓓ United Kingdom conformity mark
- Ⓔ Consult user manual
- Ⓕ Medical device
- Ⓖ UDI barcode
- Ⓗ Unique Device Identifier, with bar code
- Ⓘ Serial Number
- Ⓙ Reference number
- Ⓚ Seat width
- Ⓛ Product name
- Ⓜ Date of manufacture

	Maximum load of the wheelchair or Maximum occupant mass without any additional load
	Consult user manual
	Indicates a hazardous situation that could result in serious injury or death if it is not avoided.

Non-locking side parts warning label

	Do not lift the wheelchair by non-locking side parts.
----------------------------------------------------------------------------------	-------------------------------------------------------

Posture belt information label

	Do not lift the wheelchair by non-locking side parts.
----------------------------------------------------------------------------------	-------------------------------------------------------

Reclining mechanical backrest information label

	Push on the back support tubes (1) before operating the levers (2), this is to release the auto-locked security system. This label is attached to the upper part of the backrest cane (right side).
----------------------------------------------------------------------------------	-----------------------------------------------------------------------------------------------------------------------------------------------------------------------------------------------------

Snap hook symbols

Depending on the configuration, some wheelchairs may be used as a seat in a motor vehicle, some may not.

	Tie-down positions where the restraint system straps must be placed in case of transporting the occupied wheelchair in a motor vehicle. This symbol is only attached to the wheelchair when it is ordered with the transportation kit option.
-----------------------------------------------------------------------------------	-----------------------------------------------------------------------------------------------------------------------------------------------------------------------------------------------------------------------------------------------

	Symbol for wheelchair not intended to be used as a seat in a motor vehicle. This wheelchair is not configured for passenger transport in a motor vehicle. This symbol is attached to the frame close to the identification label.
-----------------------------------------------------------------------------------	-------------------------------------------------------------------------------------------------------------------------------------------------------------------------------------------------------------------------------------------------

 **WARNING!**
Risk of serious injury or death
Depending on the configuration, some wheelchairs may be used as a seat in a motor vehicle, some may not.
– Do not use the wheelchair for seat in a motor vehicle in.

3 Product Overview

3.1 Product Description

This is a manual wheelchair with crossbar folding mechanism and swing-away leg rests.

**NOTICE!**

The wheelchair is manufactured and configured individually to the specifications in the order. The specification must be performed by a healthcare professional/ clinician according to the occupant's requirements and health condition.

- Consult a healthcare professional if you intend to adapt the wheelchair configuration.
- Any adaptation should be performed by a qualified technician.

3.2 Intended use

The medium active wheelchair is intended to provide mobility to persons limited to a sitting position, who are propelling the wheelchair themselves frequently or use the wheelchair for assisted transport.

The wheelchair is intended for persons ages 12 and up (adolescents and adults). The weight of the wheelchair occupant must not exceed the maximum occupant mass as stated in the Technical Data section and on the identification label.

The wheelchair may be used indoors and outdoors on level ground and accessible terrain.

Intended user

The intended user (or operator) is the wheelchair occupant and/or an assistant.

The operator should physically and mentally be able to use the wheelchair safely (e.g. to propel, steer, brake).

Indications

- Considerable to complete impairment of mobility due to structural and/or functional damage to the lower extremities.
- Sufficient strength and gripping function of arms and hands to propel the wheelchair.

Contraindications

There are no contra-indications known, when using the wheelchair as intended.

3.3 Main parts of the wheelchair

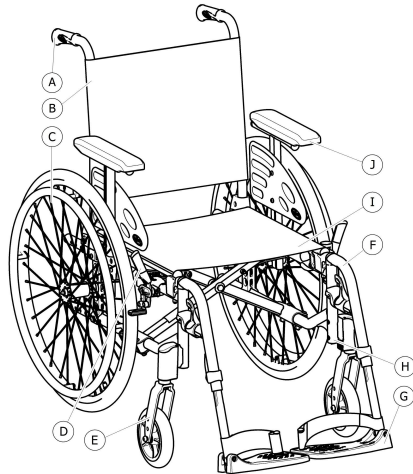

Ⓐ	Push handle
Ⓑ	Backrest
Ⓒ	Rear wheel with handrim
Ⓓ	Parking brake
Ⓔ	Front fork with castor
Ⓕ	Leg rests, swivelling
Ⓖ	Footrest

Ⓗ	Frame
Ⓘ	Seat
⓵	Armrest



The equipment of your wheelchair may differ from the diagram as each wheelchair is manufactured individually to the specifications in the order.

3.4 Parking brakes

The parking brakes are used to immobilize the wheelchair when it is stationary to prevent it from rolling away.



WARNING!

Risk of overturning if you brake sharply

If you engage the parking brakes while you are moving, the direction of movement can become uncontrollable and the wheelchair may stop suddenly, which can lead to a collision or to you falling out

- Never engage the parking brakes while you are moving.

**WARNING!****Risk due to wheelchair being out of control**

- The parking brakes must be operated simultaneously.
- Do not engage the parking brakes to slow down the wheelchair.
- Do not lean on the parking brakes for support or transfer.

**WARNING!****Risk of overturning**

- The parking brakes will not operate correctly unless there is sufficient air in the tyres. Ensure the correct tyre pressure, *11.3 Tyres, page 62*.

**CAUTION!****Risk of pinching or crushing**

There may be a very small gap between the rear wheel or the armrest front socket and the parking brake with the risk that you could trap your fingers.

- Keep your fingers away from movable parts when using the brake, always keep your hand on the brake lever.

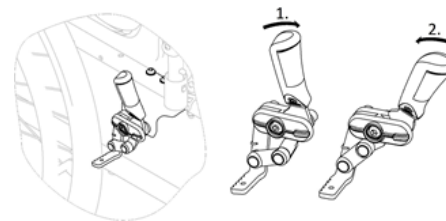

The distance between the brake shoe and the tyre can be adjusted. The adjustment must be carried out by a qualified technician.

Standard brake

1. To engage the brake, push the brake lever forwards with the palm as far as possible.
2. To disengage the brake, pull the brake lever backwards with the low fingers.



The lever of the push handle can be folded back to facilitate transfers. To do so, pull up the lever and fold it backwards.



An assistant's brake (drum brake is available as an option, the assistant can brake the wheelchair while it is moving, please read section *Braking During Use* locating in *6.1 Safety Information, page 35*

3.5 Backrest

There are three types of backrest (Fixed, Folding and Reclining) available.



WARNING!

Risk of injury to the assistant and damage to the wheelchair

Tilting the chair with a heavy occupant can hurt the assistant's back and damage the chair.

- Make sure to be able to safely control the wheelchair with a heavy occupant before performing a tilting manoeuvre.

3.5.1 Standard Backrest Cover



A standard backrest cover is available for all backrest types. These covers are not adjustable.



WARNING!

Risk of tipping

If the standard backrest cover become slack, the tipping point of your wheelchair is changed for the worse.

- Slack standard backrest cover must be replaced by a qualified technician.

3.5.2 Backrest cover height

The backrest cover height can be adjusted for all backrest types.



WARNING!

Risk of tipping

The hanging of additional load (back pack or similar items) onto your wheelchair back posts can affect the rearward stability of your wheelchair. This can cause the chair to tip backwards causing injury.

- Therefore, Invacare strongly recommend the use of anti-tip devices (available as an option) when using your back posts with additional load (back pack or similar items).



The height of the backrest cover can be adjusted on the back support tubes. The adjustment must be carried out by a qualified technician.

3.5.3 Fixed backrest

Fixed backrest of 0° and 7°: these two backrests do not require adjustments.

3.5.4 Folding backrest

To save space for transporting the wheelchair, the backrest can be folded.

3.5.4 Folding backrest

To save space for transporting the wheelchair, the backrest can be folded.

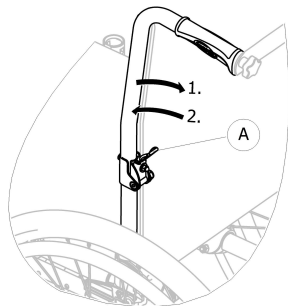

Folding and unfolding the backrest

1. Operate lever **A** by pulling it and fold the top of the backrest.
2. To return to the initial position, bring the top in the vertical position; it locks automatically.

3.5.5 Reclining Backrest

To achieve a more comfort position for the user, the backrest can be reclined.

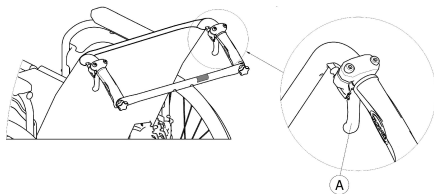

WARNING!

Risk of tipping

Do not move the wheelchair when the backrest is in reclined position.

- Invacare strongly recommend the use of anti-tip devices (available as an option) when the backrest is in reclined position.

Backrest angle

The angle of the backrest can be adjusted in four steps (0° to 30°) with the mechanical version, and step less with the gas struts version.



WARNING!

Risk of injury

- Always make these adjustments before the user settles down in the wheelchair to prevent injuries.
- Invacare strongly recommends the use of anti-tip devices (available as an option) in combination with all rear wheel positions when you use your backrest with an angle of 12° and more.

**CAUTION!****Risk of pinching or crushing fingers**

There is always a risk of getting fingers pinched in mechanical parts of the wheelchair.

- Be careful when activating the control levers of the reclining backrest.

**NOTICE!**

- Push on the backrest canes before operating the levers, this is to release the auto-locked security system.

1. Release the auto-locked system by pushing on the backrest canes.
2. Simultaneously pull the control levers (A) to provides the same angle on both sides.
3. Release the levers when you reach the desired angle.

3.6 Backbrace for the backrest

The backbrace links the two push handles, provides tension to the backrest upholstery and must always be in position on recliner versions.

**CAUTION!**

- Do not use the backbrace to push the wheelchair. The backbrace is not a push bar!
- Do not attempt to lift the wheelchair using the backbrace; it may come loose and it could break.
- Keep your fingers away from movable parts and sharp edges to prevent injuries.

Folding the backbrace

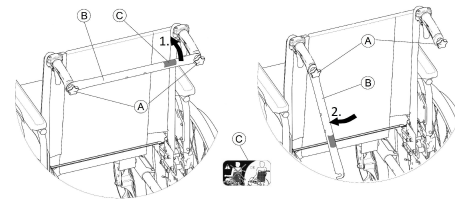

1. Slightly loosen the two hand screws (A), pull up the backbrace (B) and swivel it downwards along the backrest.
2. Fold the backbrace (B) until it is in vertical position.

Unfolding the backbrace

1. Fold the backbrace (B) upwards.
2. Align the backbrace (B) with the push handle and push it down on the hand screw (A).
3. Firmly tighten the hand screw (A) and makes sure that the TWO hand screws (A) are properly tighten .



It is important to ensure that the backbrace is correctly fitted and engaged at all times when the chair is in use. It should not be left hanging loose (see label C on the backbrace).



3.7 Push handles



NOTICE!

- Always check the push handles before using the wheelchair, as to whether the hand grips are secure, cannot be turned and cannot be pulled off.

Height adjustable, integrated push handles (optional)

The height adjustable, integrated push handles allow any assistant to adjust the handles to a comfortable level.

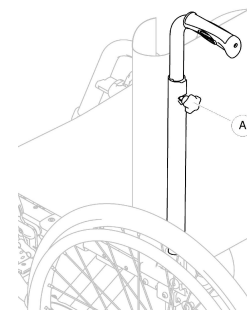

1. To set the height of the push handles, loosen the knob **A**, push the handle to the desired position and tighten the knob again.



CAUTION!

- If the knob is not correctly tightened, the push handle could accidentally come off the backrest tube while pushing it upwards.
- Make sure that the knob is firmly tightened.

3.8 Armrests



WARNING! Risk of injury

- Always make these adjustments before the user settles down in the wheelchair to prevent injuries.
- Invacare strongly recommends the use of anti-tip devices (available as an option) in combination with all rear wheel positions when you use your backrest with an angle of 12° and more.



CAUTION! Risk of Pinching

- Keep your fingers away from movable parts during removing, fitting or adjusting the armrest.

3.8.1 Armrest, stepless height adjustable, removable

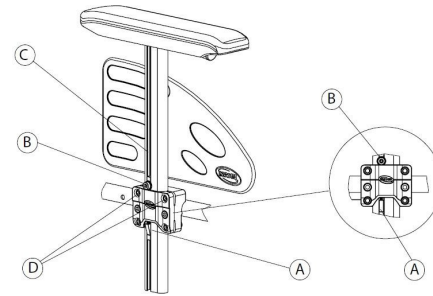

Removing

1. Apply the parking brake on both sides.
2. Previously press on the locking mechanism (A) located at the bottom of the armrest vertical bracket (if so equipped).
3. Pull the armrest by the arm cushion out of the holder.
4. To adjust how easy or difficult it is to pull the armrest out of the holder, change the degree to which the screws (D) are tightened.

Fitting

1. Push the armrest into the holder.

Adjusting the height

1. Loosen the screw ⑥ with 5 mm Allen key in the groove ③ of the armrest tube.
2. Move the armrest upwards or downwards until you reach the desired height, while keeping screw ⑥ in place (at the top edge of the holder).
3. Tighten the screw ⑥ (5–6 Nm).
4. Perform the setting on both sides.

3.8.2 Armrest, foldable and removable

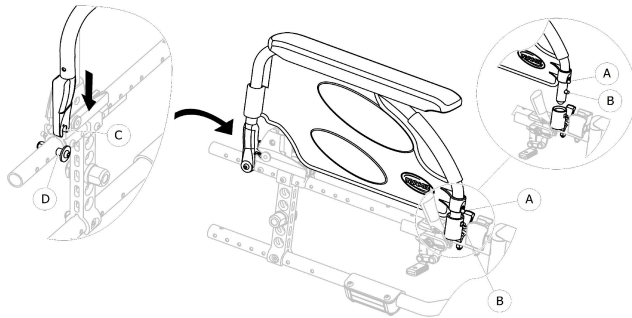

Folding

1. Grip the armrest by the armpad or by the front curve and fold it back.

Front removing

1. Press and hold the armrest release push pin ① at the front.
2. Remove armrest from armrest socket by pulling straight up and fold it back.

Front fitting

1. Push the armrest down and until the front release button ② snaps into its armrest socket hole.
2. Ensure button protrudes fully through socket hole.

Rear removing

1. Remove armrest from armrest bracket ④ by pulling straight up on the armrest.

Rear fitting

1. Position armrest support ③ over rear armrest bracket ④.
2. Push the armrest down until a clear “click” is heard when it’s locked into the armrest bracket ④.

3.9 Leg rests



WARNING!

Risk of injury

- Never lift the wheelchair by the footrest supports or leg rests.

**CAUTION!****Risk of pinching or crushing fingers**

There are swing mechanisms where you could trap your fingers.

- Be careful when using, swinging, disassembling or adjusting these mechanisms.

**NOTICE!****Risk of damage to the leg rest mechanism**

- Do not place anything heavy, or let children sit on the leg rest.

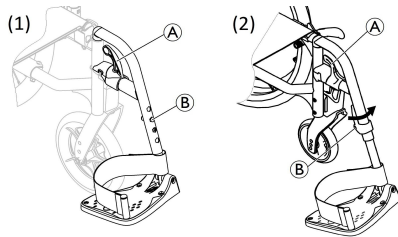
3.9.1 Swing away leg rests**Swing outwards**

1. Activate the release lever (A) and swing the leg rests to the outside.

Swing forwards

1. Swing the leg rest forwards until it engages.

Unhinging

1. Activate the release lever (A).
2. Pull the leg rest upwards.

Hinging

1. Hinge the leg rest on the front of the frame and swing it forwards until it engages.

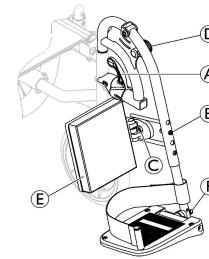
3.9.2 Swing away, Angle Adjustable Leg Rests**Swing outwards**

1. Activate the release lever (A) and swing the leg rests to the outside.

Swing forwards

1. Swing the leg rest forwards until it engages.

Unhinging

1. Activate the release lever (A).
2. Pull the leg rest upwards.

Hinging

1. Hinge the leg rest on the front of the frame and swing it forwards until it engages.

Adjusting angle

There are nine preset positions available for angle adjustment.

1. Loosening the knob ① and pull it up with one hand while supporting the leg rest with your other hand.
2. Adjust into one of nine preset positions, downwards the knob ① into the desired position and firmly tighten the knob.

Swinging calf pad and adjustment

The calf pad ② swings away during transfers and has three depth adjustment options.

1. After loosening the fixing screw ③ adjust to the desired depth and firmly tighten the fixing screw.
Invacare recommends that depth adjustment is carried out by a qualified technician.

Adjusting foot plate

There are three different foot plates available.

1. Loosening the fixing bolt ④ with 10 mm spanner.
 - Height adjustable foot plates, version (1)
 - Adjust into one of four preset positions and tighten the fixing bolt (5 Nm) ④ into the desired position.

2. Height adjustable foot plates, version (2)
 - Loosening the fixing screw ⑤ with 5 mm Allen key.
 - Adjust into one of four preset positions and tighten the fixing screw (5 Nm) ⑤ into the desired position..
3. Height, depth and angle adjustable foot plates
 - Loosening the screw ⑥ with 5 mm Allen key.
 - Adjust into the depth and angle positions and firmly tighten the screw (12 Nm) ⑥ into the desired position.

Invacare recommends that foot plate adjustment is carried out by a qualified technician.



To ensure a good position of the feet, two types of straps can be provided; the heel strap (serial) and the calf strap (optional) attached to the leg rest support. Both adjustable by hook and loop fasteners or sliding buckle.

3.10 Anti-tip device

An anti-tip device limits the extent of tipping backwards of the wheelchair.

There is a specific anti-tip for transit lite version, please see it on Chapter 4.1 *Transit Lite version*, page 25

**WARNING!****Risk of overturning**

- Anti-tip devices that are incorrectly set or no longer working can lead to overturning.
- Always check that the anti-tip device is working before using the wheelchair.
- Have the anti tipper set or readjusted by a qualified technician when required.
- In some configurations, the static stability of the wheelchair may be lower than 10°; Invacare strongly recommends the use of anti-tip device (available as an option).

**WARNING!****Risk of overturning**

- On uneven or soft ground, the anti-tip device can sink into potholes or directly into the ground, thereby curtailing or eliminating its safety function.
- Only use the anti-tip device when travelling on even and firm ground.

**NOTICE!****Risk of damage**

- Never step on the anti-tip device or use it as a tipping aid.

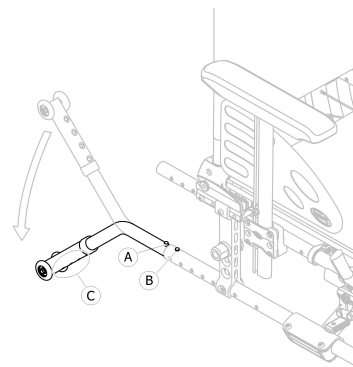
**Setting the height****WARNING!****Risk of overturning**

- Tipping angle can be reduced by decreasing the clearance of the anti-tip device (bottom from the wheels of anti-tip device to ground/floor).
- Have your anti-tip device set by a clinician/qualified technician.
 - In case of modification of your stability (new set up, new option, new add on,...), please contact your clinician/qualified technician.



This adjustment is required with reference to the position and diameter of the rear wheel as well as the user conditions and his particular safety limits.



Make sure that the anti-tip device is fitted correctly on each side (if applicable), the spring button Ⓐ and fixation Ⓒ must be locked into position.

Activating the anti-tip device

1. Release the spring button Ⓐ and swivel the anti-tip device downwards until it engages and the front release button Ⓑ snaps into the frame hole.
2. Ensure front release button Ⓑ protrudes fully through frame hole.



WARNING! **Risk of tipping**

An activated anti-tip device can catch when negotiating a step or an edge.

- You can deactivate the anti-tip device before driving over a step or kerb.
- Go through the obstacle and activate again immediately the anti-tip device.

Deactivating the anti-tip device

1. Release the spring button Ⓐ and swivel the anti-tip device upwards until it engages and the front release button Ⓑ snaps into the frame hole.



WARNING! **Risk of overturning**

- Always advise the user if you deactivate the anti-tip devices.

3.11 Seat Cushion

A suitable cushion is recommended to provide an even pressure distribution on the seat.



CAUTION! **Risk of instability**

Adding a cushion to the seat will raise your height above the ground and can affect your stability in all directions. If a cushion is changed it may also change the user's stability.

- If the thickness of the cushion is changed, a complete set up of the wheelchair need to be done by a qualified technician.
- We recommend using an Invacare or Matrix cushion with anti-slip base cover in order to prevent sliding.

4 Options

4.1 Transit Lite version

The transit lite version is designed to be driven only by the attendant. To facilitate sideways transfers and save space, the wheelchair is equipped with rear wheels of 305 mm (12").

 The distance between the brake shoe and the tyre can be adjusted. The adjustment must be carried out by a qualified technician.

Transit Lite parking brake

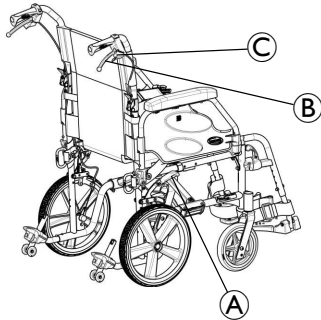

Transit version has a dedicated parking brake system which can be operated by the user or the attendant:

- **User parking brakes:**
 1. To engage the brake, push the brake lever **A** forwards with the palm as far as possible.
 2. To disengage the brake, pull the brake lever **A** backwards with the low fingers.
- **Attendant parking brakes:**
 1. To park, pull firmly the brake lever **B** and move safety lever **C** upward.
 2. To release, pull the brake lever **B** until the safety lever disengages itself.

Brake system must be deactivated where it has been activated:

- When the attendant brake has been activated, please release the brake by the attendant lever.
- When a user brake has been activated, please release the brake by the user lever.

Transit Lite folding backrest with wider push handles

Transit version has a dedicated folding backrest with wider push handle (Seat Width + 75 mm).

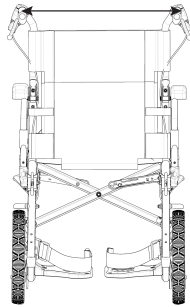

WARNING!

Risk of tipping / injury

- Max load on the pocket: 2,5 kg

In addition, a backrest height adjustment can be done by a qualified technician, from 430 mm to 510 mm. For additional information, see service manual.

Transit Lite armrests

Transit Lite version has dedicated armrests:

- A stepless height adjustable and removable armrest
- A foldable and removable armrest:

Folding

1. Grip the armrest by the armpad or by the front curve and fold it back.

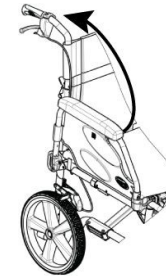

Front removing

1. Press and hold the armrest release push pin **A** at the front.
2. Remove armrest from armrest socket by pulling straight up and fold it back.

Front fitting

1. Ensure button protrudes fully through socket hole.
2. Push the armrest down and until the front release button **B** snaps into its armrest socket hole.

Rear removing

1. Press and hold the armrest release push pin **C** at the rear.
2. Remove armrest from armrest socket by pulling straight up on the armrest.

Rear fitting

1. Position armrest over rear armrest socket.
2. Push the armrest down until the rear release button **D** snaps into its armrest socket hole.

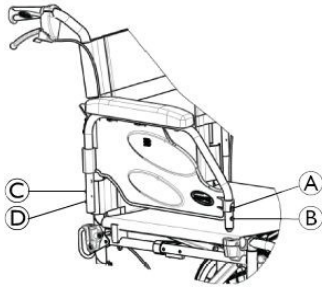

Transit Lite anti-tip devices

Transit version has dedicated anti-tip devices (if so equipped). For more information on the anti-tip devices please see the general anti-tip device section located in *Chapter 3.1 Product Description, page 12*

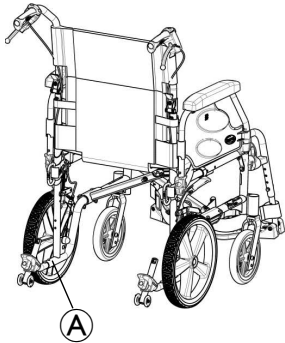

To negotiate a step or an edge, springs can be released to briefly remove the anti-tip device tubes. For more information, see general anti-tip device section.

1. Push the spring button (A) for remove the anti-tip device.
2. Go through the obstacle.
3. Reinsert immediately the anti-tip device.

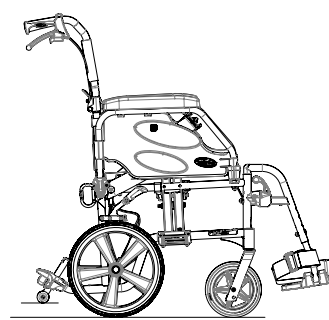

H 485

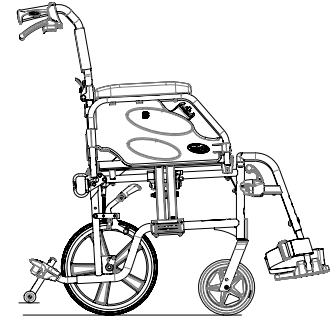

H 510

Transit Lite integrated tipper aids

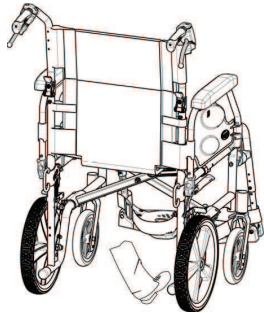

1. Hold the wheelchair by the push handles.
2. Press the tipper aid with your foot and hold the wheelchair in the tipped position until you have overcome the obstacle.

Transporting the Occupied Transit Lite Wheelchair in a Vehicle

The Transit Lite wheelchair has four tie-down points for securing it in a vehicle: two at the rear and two at the front. These positions are designed for attaching snap hooks to secure the wheelchair safely during transport.

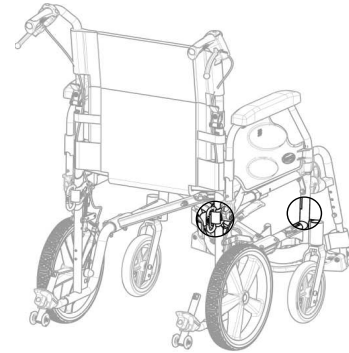

For more information see *Transporting the Manual Wheelchair without Occupant* and *Transporting the Occupied Wheelchair in a Vehicle* in the section *7.1 Safety Information, page 43*.

4.2 Posture Belt

The wheelchair can be equipped with a posture belt. It prevents the user from sliding downward in the wheelchair or from falling out of the wheelchair. The posture belt is not a positioning device.

**WARNING!**

A loose belt can cause the user to slip down and create a risk of strangulation.

- The posture belt should be mounted by a qualified technician and fitted by a healthcare professional.
- Always make sure that the posture belt is tightly fitted across the lower pelvis.
- Each time the posture belt is used, check if it fits properly. Changing the seat and/or backrest angle, the cushion and even your clothes influence the fit of the belt.

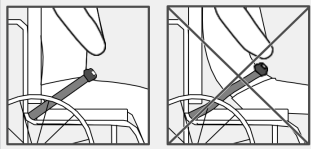
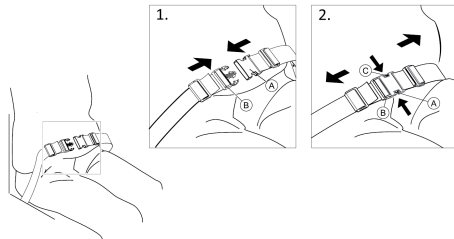
**Closing and opening the posture belt**

Ensure that you are sitting fully back in the seat and that the pelvis is as upright and symmetrical as possible.

1. To close, push the catch (A) into the buckle clasp (B).
2. To open, push the PRESS button (C) and pull the catch (A) out of the buckle clasp (B).

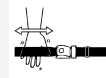
Adjusting the length

The posture belt has the good length, when there's just sufficient space for a flat hand between body and belt.

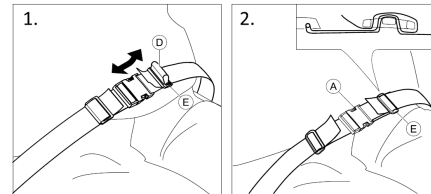

1. Shorten or extend the loop (D) as required.
2. Thread loop (D) through catch (A) and plastic buckle (E) until the loop is flat.
3. Ensure loop (D) is perfectly fitted in plastic buckle (E).
4. Secure adjustment with the strap extremity fitted in the buckle (E).

**WARNING!****Risk of sliding and strangulation / Risk of falling**

- Do the adjustments on both sides equally, so that the buckle clasp remains in a central position.
- Ensure that both strap extremities are threaded two times into the buckle (E) to avoid the belt from loosening.
- Make sure that the belts do not get caught in the spokes of a rear wheel.

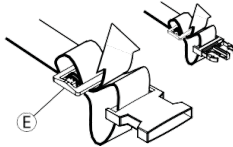

4.3 Headrest



The height and the removal are operated by the handwheel. The bar is equipped with an adjustable stop block.

Height adjustment

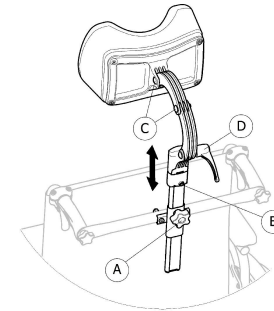

1. Loosen the screw in the stop block (B).
2. Loosen the handwheel (A).
3. Adjust the headrest to the desired position.
4. Re-tighten the handwheel (A) down to the top of the headrest attachment.
5. Slide the stop block (B).
6. Re-tighten the screw.



It is now possible to remove the headrest and reinsert it in the desired position without further adjustments.

Depth / angle adjustment

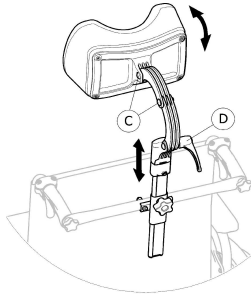

1. Loosen the handle ④.
2. Loosen the screws ③.
3. Adjust the depth and angle of the headrest.
4. Re-tighten the handle and the screws.

4.4 Tipper aid

With the tipper aid, an assistant can tip the wheelchair more easily, in order to navigate steps for example.



WARNING! Risk of overturning

- Ensure that the tipper aid does not project beyond the external diameter of the rear wheel.

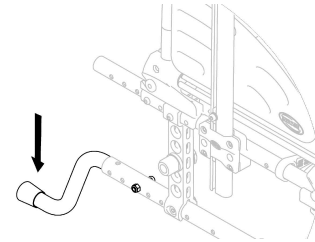

1. Hold the wheelchair by the push handles.
2. Press the tipper aid with your foot and hold the wheelchair in the tipped position until you have overcome the obstacle.

4.5 Table tray



WARNING!

Risk of tipping / injury

- Max load on the table: 8 kg



CAUTION!

Risk of discomfort / minor bruises

- Make sure that the elbows of the user are placed on the table when pushing the wheelchair. If the elbows protrude from the table while pushing the wheelchair, there is a risk of discomfort or minor bruises.

Depth adjustment

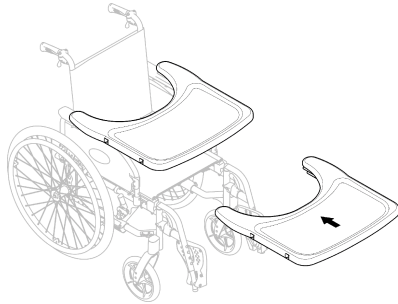

Slide the table tray forwards or backwards to adjust to the required depth.



CAUTION!

Risk of discomfort

- When adjusting the depth of the table, make sure not to squeeze the stomach of the user.

4.6 Drip stand



WARNING!

Risk of tipping / injury

- Max load on the drip stand: 4 kg (2 x 2 kg)



The he rod of the drip stand must always be placed in a vertical position, i.e in a 90 degree angle to the ground, no matter the position of the backrest or the wheelchair.

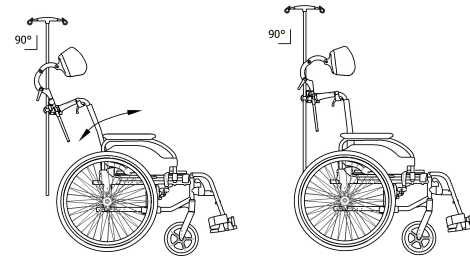

Adjusting the Height and Angle

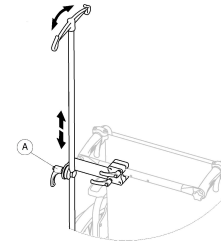

1. Loosen the lever (A).
2. Adjust the drip stand to the desired height or/and angle.
3. Firmly tighten the lever (A).

4.7 Passive illumination

You can attach reflectors to the rear wheels.

4.8 Cane holder

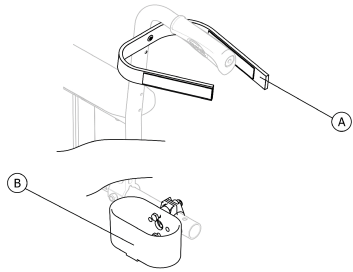

WARNING!

Risk of overturning

- Ensure that the cane holder does not project beyond the external diameter of the rear wheel.

1. Place the cane in the holder (B).
2. Fix the top of the cane to the backrest (A).

5 Setup

5.1 Safety Information

**CAUTION!****Risk of injury**

- Before using the wheelchair, check its general condition and its main functions in maintenance schedule chapter in *8.1 Safety Information, page 51*

**WARNING!**

- Check all parts for shipping damage before use.
- In case of damage, do not use the device. Contact your Invacare provider for further instructions.

Your authorized provider will supply your wheelchair ready for use and will explain the main functions, ensuring that the wheelchair meets your needs and requirements and it is properly adjusted for safe use.

If you receive your wheelchair folded, read section Folding and unfolding the wheelchair.

5.2 Delivery Check

Any transport damage must be reported immediately to the transport company. Remember to keep the packaging until the transport company has checked the goods and a settlement has been reached.

6 Using the wheelchair

6.1 Safety Information



WARNING!

Risk of accidents

Uneven tyre pressure can have a huge effect on handling.

- Check the tyre pressure before each journey.



WARNING!

Risk of falling out of the wheelchair

When using front wheels that are too small, the wheelchair could get stuck at curbs or in floor grooves.

- Make sure that the front wheels are suitable for the surface you're driving on.



CAUTION!

Risk of crushing

There may be a very small gap between the rear wheel and the mudguard or armpad with the risk that you could trap your fingers.

- Ensure that you always propel your wheelchair using the handrims only

6.2 Braking during use

Whilst you are moving, you brake by transferring force to the handrim with your hands.



WARNING!

Risk of accidents

If you engage the parking brakes while you are moving, the direction of movement can become uncontrollable and the wheelchair may stop suddenly, which can lead to a collision or to you falling out.

- Never engage the parking brakes while you are moving.



WARNING!

Risk of falling of the wheelchair

If the wheelchair is rapidly decelerated by an assistant pulling at the push handles, the user may fall out of the wheelchair.

- Always apply the posture belt if present
- Make sure your assistant is qualified in transferring occupied wheelchairs.
- Operate the two brakes simultaneously and do not take slopes exceeding 7° to ensure perfect control of the wheelchair steering.
- Always use the parking brakes to secure the wheelchair during short or long stops.

**CAUTION!****Risk of burning your hands**

If you brake for a long time, a lot of frictional heat is produced at the handrims (especially anti slip handrims)

- Wear suitable gloves.

1. Hold the handrims and press evenly with both hands until the wheelchair stops.

Braking with an assistant

With an assistant's brake (drum brake) an assistant can brake the wheelchair while it is moving. The assistant's brake can also be used as a parking brake.

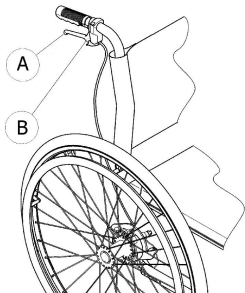

1. To brake, pull the brake lever ① on the push handle.
2. To park, pull the brake lever firmly and move the safety lever ② upwards.
3. To release, pull the brake lever until the safety lever disengages.

6.3 Move to/from the wheelchair

**WARNING!****Risk of burning your hands**

There is a high risk of overturning during the transfer.

- Only get in and out without assistance if you are physically able to do so.
- When transferring, position yourself as far back as possible in the seat. This will prevent damaged upholstery and the possibility of the wheelchair tipping forward.
- Make sure that both castors are facing straight to the front.

**WARNING!****Risk of overturning**

The wheelchair could tip forwards if you stand on the footrest.

- Never stand on the footrest when getting in and out.

**CAUTION!**

A heavy load hanging on the backrest can affect the wheelchair's centre of gravity.

- Change your driving style accordingly.

**CAUTION!**

If you disengage or damage the brakes the wheelchair could roll away out of control.

- Do not support yourself on the brakes when getting in and out.

**NOTICE!**

The mudguards and armrests could become damaged.

- Never sit on the mudguards or armrests when getting in and out.



1. Propel the wheelchair as near as possible to the seat that you want to move to.
2. Engage the parking brakes.
3. Remove the armrests or move them upwards out of the way.
4. Detach the leg rests or swing them outwards.
5. Place your feet on the ground.
6. Hold the wheelchair and, if necessary, also hold a fixed object in the vicinity.
7. Move slowly to chair.

6.4 Driving and Steering the Wheelchair

You drive and steer the wheelchair using the handrims. Before driving without an assistant you must find your wheelchair's tipping point.

**WARNING!****Risk of tipping**

The wheelchair can tip backwards.

- When finding the tipping point, an assistant must stand immediately behind the wheelchair to catch it if it tips over.
- To prevent tipping, install an anti-tipper device.



WARNING!

Risk of tipping

The wheelchair can tip forward.

- When setting up your wheelchair, test its behaviour in terms of tipping forward and adjust your driving style accordingly.

Finding the Tipping Point

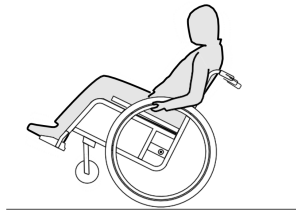

1. Release the brake.
2. Roll backwards a short distance, grasp both handrims firmly and push forwards with a slight kick.
3. The shift in weight and steering in opposite directions with the handrims will enable you to identify the tipping point.

6.5 Negotiating steps and kerbs



WARNING!

Risk of overturning

When negotiating steps you could lose your balance and tip the wheelchair over.

- Always approach steps and kerbs slowly and carefully.
- Do not go up or down steps that are higher than 25 cm.



CAUTION!

An activated anti-tip device prevents the wheelchair from tipping backwards.

- Deactivate the anti-tip device before going up or down steps or kerbs.



WARNING!

Risk of injury to the assistant and damage to the wheelchair

Tilting the chair with a heavy user can hurt the assistant's back and damage the chair.

- Make sure to be able to safely control the wheelchair with a heavy user before performing a tilting manoeuvre.

Going down a step with an assistant

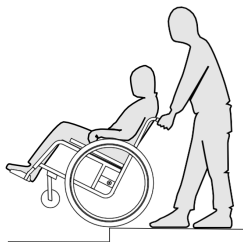

1. Move the wheelchair right up to the kerb and hold the handrims.
2. The assistant should hold both push handles, place one foot on the tipper aid (if installed) and tilt the wheelchair backwards so that the front wheels lift off the ground.
3. The assistant should then hold the wheelchair in this position, push it carefully down the step and then tilt it forwards until the front wheels are back on the ground.

Going up a step with an assistant



WARNING!

Risk of serious injuries

Going up steps and kerbs often than the normal use can cause a fatigue break of the wheelchair backrest and the user might fall out of the wheelchair.

- Make sure that the wheelchair can be controlled by the user or the assistant before performing a tilting manoeuvre.

1. Move the wheelchair backwards until the rear wheels touch the kerb.
2. The assistant should tilt the wheelchair using both push handles so that the front wheels lift off the ground, then pull the rear wheels over the kerb until the front wheels can be placed back on the ground.

Going down a step without an assistant

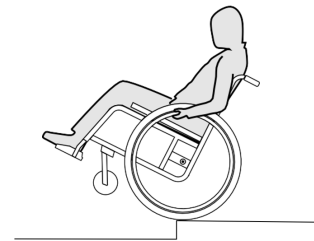

WARNING!

Risk of tipping

When going down a step without an assistant you could tip over if you cannot control your wheelchair.

- First learn how to go down a step with an assistant.
- Learn how finding the tipping point to balance on the rear wheels, *6.4 Driving and Steering the Wheelchair, page 37.*

1. Move the wheelchair right to the kerb, lift the front wheels and keep the wheelchair balanced.

2. Now slowly roll both rear wheels over the kerb. While doing this, hold the handrims firmly with both hands until the front wheels are back on the ground.

6.6 Going up and down stairs



WARNING!

Risk of overturning

When negotiating stairs you could lose your balance and overturn your wheelchair.

- Always use two assistants when negotiating stairs with more than one step.



1. You can go up and down stairs by taking them one step at a time, as described above. The first assistant should stand behind the wheelchair holding the push handles. The second assistant should hold a solid part of the front frame to steady the wheelchair from the front.

6.7 Negotiating Ramps and Slopes



WARNING!

Risk due to wheelchair being out of control

When negotiating slopes or gradients your wheelchair could tip backwards, forwards or sideways.

- Always have an assistant behind the wheelchair when approaching long slopes.
- Avoid lateral slopes.
- Avoid slopes of more than 7°.
- Avoid jerking when changing direction on a slope.



CAUTION!

Your wheelchair could run away even on slightly sloping ground if you do not control it using the handrims.

- Use the parking brakes if your wheelchair is stationary on sloping ground.

Going up slopes

To go up a slope, you must create some momentum, keep up the momentum and control the direction at the same time.

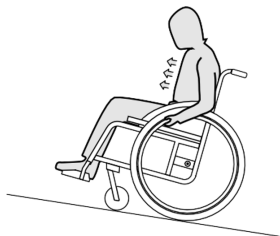

1. Bend your upper body forwards and propel the wheelchair with quick, powerful strokes on both handrims.

Going down slopes

When going down slopes, it is important to control your direction and particularly your speed.

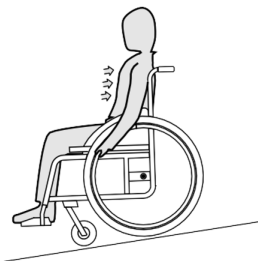

1. Lean back and carefully allow the handrims to run through your hands. You should be able to stop the wheelchair at any time by gripping the handrims.



CAUTION!

Risk of burning your hands

If you brake for a long time, a lot of frictional heat is produced at the handrims (especially anti slip handrims).

- Wear suitable gloves.

6.8 Stability and balance when seated

Some everyday activities and actions require you to lean forwards, sideways or backwards out of the wheelchair. This has a major effect on the wheelchair's stability. To keep your balance at all times, proceed as follows:

Leaning forwards



WARNING!

Risk of falling

If you lean forwards out of the wheelchair you could fall out of it.

- Never bend too far forwards and do not shift forwards in your seat to reach an object.
- Do not bend forwards between your knees to pick up something off the floor

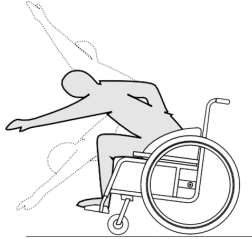

1. Point the front wheels forwards. (To do this, move your wheelchair forwards slightly then back again.)
2. Apply both parking brakes.
3. When leaning forwards your upper body must remain over the front wheels.

Reaching backwards



WARNING!
Risk of falling

If you lean too far backwards you could tip your wheelchair over.

- Do not lean out over the backrest.
- Use an anti-tip device.

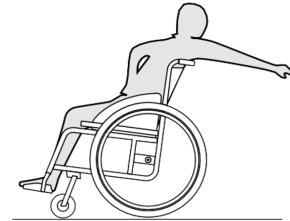

1. Point the front wheels forwards. (To do this, move your wheelchair forwards slightly then back again.)
2. Do not apply the parking brakes.
3. When reaching backwards do not reach so far that you have to change your sitting position.

7 Transport

7.1 Safety Information



WARNING!

Risk of injury if the wheelchair is not properly secured

In the event of an accident, braking manoeuvre, etc. you may suffer serious injuries from flying wheelchair parts.

- Firmly secure all wheelchair components in the means of transport to prevent them from coming loose during the journey.

7.2 Folding and unfolding the wheelchair

Folding the wheelchair

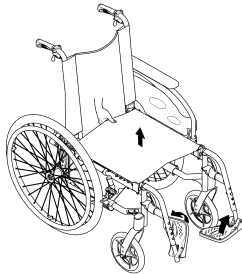

1. Remove the seat cushion, if present.
2. Fold the backbrace, if present.
3. Fold the foot plates upwards.
4. Pull the seat cover upwards.

Unfolding the wheelchair

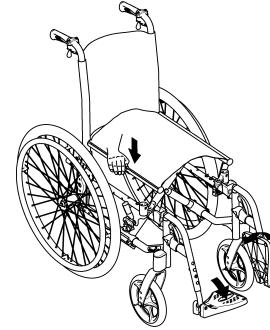

CAUTION!

Risk of getting fingers caught

There is a risk of getting your fingers caught between the seat edge and the frame.

- Never clasp the seat edge with your fingers.

1. Position the wheelchair next to you.
2. Tilt the wheelchair, if possible, gently towards you.
3. With your hand flat, press the seat edge closest to you, so that the seat surface flattens out.

- Put the wheelchair back completely on the floor and check that the seat edges on both sides are in the guide components.
- Fold the foot plates down.
- Unfolding the backbrace, if present.

7.3 Lifting the wheelchair



NOTICE!

Never lift the wheelchair by removable parts (armrests, footrests).
— Ensure the backrest posts are securely in place.

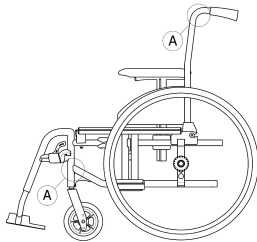

- Fold the wheelchair, see chapter 7.2 *Folding and unfolding the wheelchair*, page 43.
- Always lift the wheelchair by gripping the frame at points A.

7.4 Removing and fitting the rear wheels



WARNING!

Risk of overturning

If the removable axle of a rear wheel is not fully engaged, the wheel can become loose during use. This can lead to overturning.

- Always ensure that the removable axles are fully engaged whenever you fit a wheel.

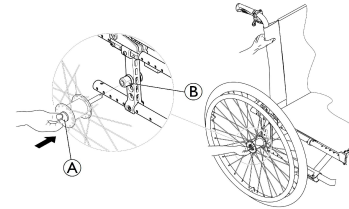

Removing the rear wheels

- Release the brakes.
- With one hand, hold the wheelchair upright.
- With the other, hold the wheel through the external spoke rim around the wheel hub.
- Using your thumb, press the removable axle button A. Keep it pressed and pull the wheel out of the adapter sleeve B.

Fitting the rear wheels

1. Release the brakes.
2. With one hand, hold the wheelchair upright.
3. With the other, hold the wheel through the external spoke rim around the wheel hub.
4. Using your thumb, press the removable axle button and hold it down.
5. Push the axle into the adapter sleeve  up to the stop.
6. Release the removable axle button and make sure that the wheel is secure.

7.5 Transporting the Manual Wheelchair without Occupant



CAUTION!

Risk of burning your hands

If you brake for a long time, a lot of frictional heat is produced at the handrims (especially anti slip handrims).

- Wear suitable gloves.

Your manual wheelchair may be transported without restrictions, whether by road, rail or by air. Individual transport companies have, however, guidelines which can possibly restrict or forbid certain transport procedures. Please ask the transport company regarding each individual case.

- Invacare strongly recommends securing the manual wheelchair to the floor of the transporting vehicle.

7.6 Transporting the Occupied Wheelchair in a Vehicle

Even when the wheelchair is properly secured and the following rules are met, injuries to passengers may occur in a collision or sudden stop. Therefore Invacare strongly recommends transferring the wheelchair user to the vehicle seat with the 3-point passenger restraint system on. Do not make alterations or substitutions to points of the wheelchair (structure, frame or parts) without the written consent of Invacare Corporation. The wheelchair has been successfully tested according to the requirements of ISO 7176–19 (Frontal impact).



WARNING!

Risk of serious injury or death

To use the wheelchair as a seat in a vehicle the backrest height minimum must be at least 400 mm.

To transport the wheelchair with user in a vehicle, a restraint system must be installed in the vehicle. Wheelchair tie-downs and occupant restraint systems must be approved according to ISO 10542-1. Contact your local Invacare authorized provider for more information on getting and installing an approved and compatible restraint system.



WARNING!

If, for some reason, it is impossible to transfer the wheelchair user to a vehicle seat, the wheelchair can be used as a seat in a vehicle if the following procedures and regulations are followed. A transportation kit (optional) have to be fitted on the chair for such a purpose.

- The wheelchair must be secured in the vehicle with a 4-point wheelchair restraint system.
- The user must wear a 3-point passenger restraint system secured to the vehicle.
- The user can be additionally secured with a posture belt in the wheelchair.



WARNING!

Safety restraint devices must only be used when the wheelchair user's weight is 22 kg or more (ISO-7176-19).

- Do not use the wheelchair as a seat in a vehicle when the user weight is lower than 22 kg.



WARNING!

- Before journey contact transporter and request information about the capability for the below required equipment.
- Make sure there is sufficient free space around the wheelchair and user to avoid the user making contact with other vehicle occupants, unpadded parts of the vehicle, wheelchair options or anchor points of the restraint system.



WARNING!

- Make sure the tie-down points at the wheelchair are not damaged and that the parking brakes are fully functional.
- It's recommended to use puncture-proof tyres during transport to avoid brake problems due to reduced tyre pressure.

**WARNING!**

Injury or damage may occur from wheelchair components or options loosened during a collision or sudden stop.

- Ensure all removable or detachable components and options are removed from the wheelchair and securely stored in the vehicle.
- It is essential to have your wheelchair checked by a qualified technician after an accident, collision etc.

**NOTICE!**

- Refer to the user manuals supplied with the restraint systems.
- The following illustrations may differ depending on the restraint system supplier.



The choice of wheelchair configuration (seat width and depth, wheelbase) influences manoeuvrability and access to motor vehicles.

Securing the wheelchair with a 4-point restraint system

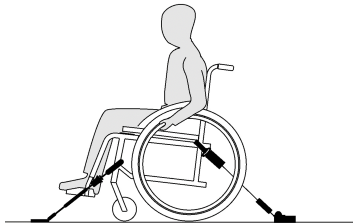
**WARNING!**

- Place the wheelchair with the user forward-facing in direction of vehicle travel.
- Engage the wheelchair parking brakes.
- Activate anti-tip device (if installed).

The wheelchair tie-down positions where the 4-point restraint system straps must be placed are marked with snap hook symbols (see following figures and section 2.3 *Labels and symbols on the product, page 10*).

1. Using the front and rear straps of the 4-point restraint system, secure the wheelchair to the vehicle mounted rails. Refer to the user manual supplied with 4-point restraint system.

Front side tie-down positions for belt straps:

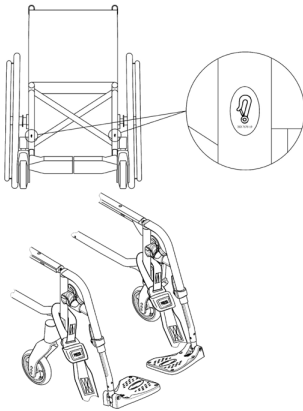

1. Attach the front straps above the castor supporters as shown in the figure above (see location of the attachment labels).
2. Attach front straps to the rail system referring to best practice recommended instructions from the 4-point restraint system manufacturer.
3. Disengage parking brakes and apply tension front straps by pulling the wheelchair backwards from the rear.
4. Re-engage parking brakes.

Rear side tie-down positions for snap hooks:

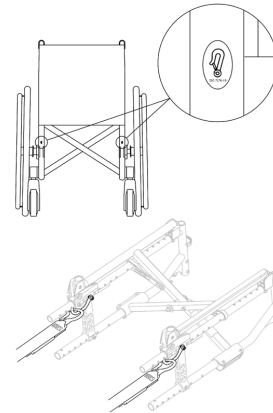

1. Attach the snap hooks to the orange rings as shown in the two figures above (see location of the attachment labels).
2. Attach rear straps to the rail system referring to best practice recommended instructions from the 4-point restraint system manufacturer.
3. Tighten the straps.



NOTICE!

- Make sure that the snap hooks are covered with slip resistant material to avoid laterally slipping on the axle.

! NOTICE!

- Check the plungers are fully engaged on both sides and located in the same position of the cut-out section of the rail.
- Make sure that the angle between the rails and the straps lies between 40° and 45°.

Fit posture belt**WARNING!**

- The posture belt can be used in addition to but never as a substitute for an approved 3-point passenger restraint system.

1. Adjust posture belt to fit the wheelchair occupant, see section Posture Belt.

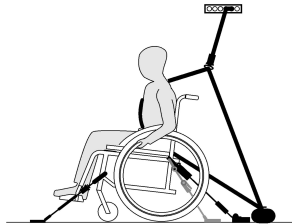
Fastening the 3-point passenger restraint system**NOTICE!**

- The illustration above may differ depending on the restraint system supplier.

**WARNING!**

- Ensure the 3-point passenger restraint system fits as tightly across the user's body as possible without discomfort and no part is twisted.
- Ensure the 3-point passenger restraint system is not held away from the user's body by parts of the wheelchair such as armrests or wheels etc.
- Ensure the 3-point passenger restraint system has a clear path from the user to the anchor point without interference by any part of the vehicle, wheelchair, seating or option.
- Ensure the pelvic belt fits snugly over the occupant's pelvis and is not allowed to ride up into the abdominal area.
- Ensure the user is able to reach the release mechanism unaided.





NOTICE!

- Apply the pelvic belt of the 3-point passenger restraint system low across the pelvis so that the angle of the pelvic belt is within the preferred zone (A) of 30° to 75° to the horizontal. A steeper angle is preferred, but never exceeding 75°.

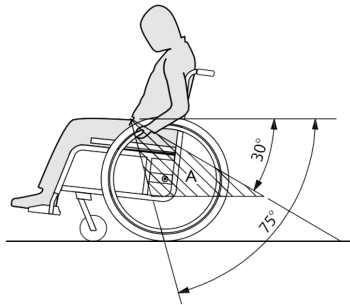

8 Maintenance

8.1 Safety Information



WARNING!

Some materials deteriorate naturally over time.

This could result in damage to wheelchair components.

- Your wheelchair should be checked by a qualified technician at least once a year or if it has not been used for a long period.



Packaging for return

The wheelchair shall be sent to the authorized provider in an appropriate packaging to avoid damage during the shipment.

8.2 Maintenance schedule

To ensure safe and reliable operation, carry out the following visual checks and maintenance regularly or have it carried out by another person

	weekly	monthly	annually
Check the tyre pressure	x		
Check that rear wheels are seated correctly	x		
Check posture belt	x		

Check the folding mechanism		x	
Check the castors and its fixation		x	
Check bolts		x	
Check spokes		x	
Check parking brakes (mechanism and cable)		x	
Have wheelchair checked by a qualified technician			x

General visual check

1. Examine your wheelchair for loose parts, cracks or other defects.
2. If you find anything, stop using your wheelchair immediately and contact an authorized provider.

Check the tyre pressure

1. Check the tyre pressure, see section “Tyres” for more information.
2. Inflate the tyres to the required pressure.
3. Check the tyre tread at the same time.
4. If necessary, change the tyres.

Check that rear wheels are seated correctly

1. Ensure that the axle ball is outside its receiver by visually checking it and pull on the rear wheel to check that the removable axle is seated correctly. The wheel should not come off.

2. If the rear wheels are not engaged properly, remove any dirt or deposits. If the problem persists, have the removable axles re-fitted by a qualified technician.

Check posture belt



NOTICE!

- Loose posture belts must be adjusted by an authorized provider.
- Damaged posture belts must be replaced by a qualified technician.

Check the castors and its fixation

1. Check that the castors turn freely.
2. Push and pull in the 3 directions (front and rear; left and right; up and down) to observe that is no free play and movement, also check that there is no visual damage.

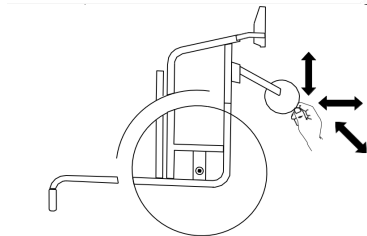

NOTICE!

- Self-locking screws/nuts or thread-locking adhesive are used for several connections. If these are loosened, they must be replaced by new self-locking screws/nuts or they must be secured using new thread-locking adhesive.
- Self-locking screws/nuts must be replaced by a qualified technician

Check the spoke tension

1. The spokes should not be loose or distorted.
2. Broken spokes must be replaced by a qualified technician.
3. Loose spokes must be tightened by a qualified technician.

Check the parking brakes

1. Check that the parking brakes are positioned correctly. The brake is set correctly if the brake shoe depresses the tyre by a few millimetres when the brake is engaged.
2. If you find that the setting is not correct, have the brakes correctly adjusted by a qualified technician



NOTICE!

- The parking brakes must be reset after replacing the rear wheels or changing their position.

Checking after a heavy collision or blow



NOTICE!

The wheelchair can sustain visibly undetectable damage as a result of a heavy collision or hard blow.

- It is essential to have your wheelchair checked by a qualified technician after a heavy collision or hard blow.

Repairing or changing an inner tube

1. Remove the rear wheel and release any air from the inner tube.
2. Lift one tyre wall away from the rim using a bicycle tyre lever. Do not use sharp objects such as a screwdriver which could damage the inner tube.
3. Pull the inner tube out of the tyre.
4. Repair the inner tube using a bicycle repair kit or, if necessary, replace the tube.
5. Inflate the tube slightly until it becomes round.
6. Insert the valve into the valve hole on the rim and place the tube inside the tyre (the tube should lie right round the tyre with no creases).
7. Lift the tyre wall over the edge of the rim. Start close to the valve and use a bicycle tyre lever. When doing this, check all the way round to ensure that the inner tube is not trapped between the tyre and the rim.
8. Inflate the tyre to the maximum operating pressure. Check that no air is escaping from the tyre.



Spare parts

All spare parts may be obtained from an Invacare authorized provider.

8.3 Cleaning and disinfection

8.3.1 General Safety Information



CAUTION!

Risk of Contamination

Take precautions for yourself and use appropriate protective equipment.



NOTICE!

Wrong fluids or methods can harm or damage the product.

All cleaning agents and disinfectants used must be effective, compatible with one another and must protect the materials they are used to clean.

- Never use corrosive fluids (alkalines, acid etc.) or abrasive cleaning agents. We recommend an ordinary household cleaning agent such as dishwashing liquid, if not specified otherwise in the cleaning instructions.
- Never use a solvent (cellulose thinner, acetone etc.) that changes the structure of the plastic or dissolves the attached labels.
- Always make sure that the product is completely dried before taking it into use again.



For cleaning and disinfection in clinical or long-term care environments, follow your in-house procedures.

8.3.2 Cleaning Intervals



NOTICE!

Regular cleaning and disinfection enhance smooth operation, increases the service life and prevents contamination.

- Clean and disinfect the product:
- Regularly while in use,
- Before and after any service procedure,
- When it has been in contact with any body fluids,
- Before using it for a new user.



NOTICE!

Dirt, sand and seawater can damage the bearings and steel parts can rust if the surface is damaged.

- Only expose the wheelchair to sand and sea water for short periods and clean it after every trip to the beach.
- If the wheelchair is dirty, wipe off the dirt as soon as possible with a damp cloth and dry it carefully.

1. Remove any options fitted (only options which do not require tools).
2. Wipe down the individual parts using a cloth or soft brush, ordinary household cleaning agents (pH = 6 - 8) and warm water.

3. Rinse the parts with warm water
4. Thoroughly dry the parts with a dry cloth.



Car polish and soft wax can be used on painted metal surfaces to remove abrasions and restore gloss.

Cleaning upholstery

For cleaning upholstery refer to the instructions on the labels of the seat, cushion and backrest cover.



If possible, always overlap hook and loop strips (the self-gripping parts) when washing, to minimize lint and thread build-up on hook strips and prevent damage to upholstery fabric by these.

8.3.3 Disinfection

The wheelchair may be disinfected by spraying or wiping with tested, approved disinfectants.



Spray a soft cleaning and disinfecting product (bactericidal and fungicide meeting the EN1040/ EN1276 / EN1650 standards) and follow the instructions given by the manufacturer.

1. Wipe down all generally accessible surfaces with a soft cloth and ordinary household disinfectant.
2. Allow the product to air-dry.

9 Troubleshooting

9.1 Safety Information

Faults may arise as a result of daily use, adjustments or changing demands on the wheelchair. The table below shows how to identify and repair faults. Some of the actions listed must be carried out by a qualified technician. These are indicated. We recommend that all adjustments are carried out by a qualified technician.



CAUTION!

– If you notice a fault with your wheelchair, e.g. a significant change in handling, stop using your wheelchair immediately and contact your provider.

9.2 Identifying and repairing faults

Fault	Possible cause	Action
The wheelchair does not travel in a straight line	Incorrect tyre pressure on one rear wheel	Correct tyre pressure, → 11.3 Tyres, page 62
	One or more spokes broken	Replace faulty spoke(s), → qualified technician
	Spokes tightened unevenly	Tighten loose spokes, → qualified technician

	Castor bearings are dirty or damaged	Clean the bearings or replace the castor, → qualified technician
The wheelchair tips backwards too easily	Rear wheels are mounted too far forwards	Mount the rear wheels further back, → qualified technician
	Back angle too large	Reduce the backrest angle, → qualified technician
	Seat angle too large	Mount the castor upper on the front fork, → qualified technician Select a smaller front fork, → qualified technician
The brakes are gripping poorly or asymmetrically	Incorrect tyre pressure in one or both rear tyres	Correct tyre pressure, → 11.3 Tyres, page 62
	Brake setting incorrect	Correct the brake setting, → qualified technician
Rolling resistance is very high	Tyre pressure in rear tyres is too low	Correct tyre pressure, → 11.3 Tyres, page 62
	Rear wheels not parallel	Ensure the rear wheels are parallel, → qualified technician

The castors wobble when moving fast	Too little tension in castor bearing block	Tighten the nut on the bearing block axle slightly, → qualified technician
	Castor has worn smooth	Change castor, → qualified technician
The castor is stiff or stuck	Bearings are dirty or faulty	Clean the bearings or replace the castor, → qualified technician

10 After use

10.1 Storage

! **NOTICE!**
Risk of damage to the product
Do not store the product near heat sources.
Never store other items on top of the wheelchair.
Store the wheelchair indoors in a dry environment.
Refer to temperature limitation in *11.1 Dimensions and weight, page 58*

After long-term storage (more than four months) the wheelchair must be inspected in accordance to *8.1 Safety Information, page 51*.

10.2 Disposal

Be environmentally responsible and recycle this product through your recycling facility at its end of life. Disassemble the product and its components, so the different materials can be separated and recycled individually. The disposal and recycling of used products and packaging must comply with the laws and regulations for waste handling in each country. Contact your local waste management company for information.

10.3 Reconditioning

This product is suitable for reuse. To recondition the product for a new user, carry out the following actions:

- Inspection
- Cleaning and disinfection
- Adaptation to the new user

For detailed information, see *8.1 Safety Information, page 51* and the service manual for this product.

Make sure that the user manual is handed over with the product.

If any damage or malfunction is detected, do not reuse the product.

11 Technical data

11.1 Dimensions and weight

All dimension and weight specifications refer to a wide range of the wheelchair in a standard configuration. Dimension and weight (based on ISO 7176–1/5/7) may alter according to different configurations. In some configurations, the wheelchair exceeds the recommended dimensions for a wheelchair.

! NOTICE!

- In some configurations, the overall dimensions of the wheelchair when it is ready for use exceeds the authorised limits and the access to emergency escape routes is not possible.
- In some configurations, the wheelchair exceeds the size recommended for travelling by train in the EU.

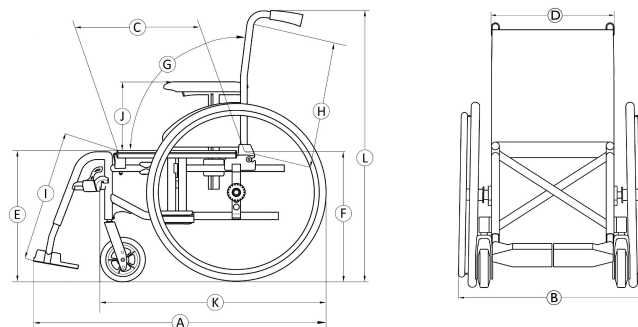

		Action 2 NG	Action 2 Transit Lite
	Maximum load of the wheelchair (*)	125 kg	125 kg
Ⓐ	Overall length with leg rest	870 – 1140 mm	990 – 1020 mm
Ⓑ	Overall width	540 – 710 mm	475 – 586 (SW +100) mm
	Folded length	870 – 1140 mm	610 mm
	Folded width	255 – 355 mm	250 mm

	Folded height	935 mm	705-780 mm
	Total mass	from 15 – 17 kg	from 13,4-13,7 kg
	Mass of the heaviest part	10 – 12 kg	10,7 kg
	Static stability	Downhill: 0° – 17° Uphill: 0° – 7° Sideways: 0° – 17°	Downhill: 0° – 16° Uphill: 0° – 7° Sideways: 0° – 14,9°
	Seat plane angle	0° - 8° (0°/3°/6°)	8° (3°)
©	Effective seat depth	435 – 460 (400-425) mm	415-446 (400-425) mm
Ⓓ	Effective seat width	370 – 505 (380/405/430/455 / 480/505) mm, in increments of 25 mm	365-460 (380/405/430/455/480) mm, in increments of 25 mm
Ⓔ	Seat surface height at front edge	480 (410/435/460/485/510) mm, in increments of 25 mm	465 (485/510) mm, in increments of 25 mm

Ⓕ	Seat surface height at rear edge	460 – 485 mm, in increments of 25 mm	460 – 485 mm, in increments of 25 mm
Ⓖ	Backrest angle	Range: 0° / +30° Fixed: 90° (7°) Recliner: 90° (0°/+30°), in increments of 10°	Fixed: 90° (7°)
Ⓗ	Backrest height	465 – 545 (430/510) mm	465 – 545 (430/ 510) mm
Ⓘ	Footrest to seat distance	330 – 460 mm, in increments of 10 mm	Steel version: 330-455mm (12,5mm Steps) Alu version: 350-475mm (10mm steps) mm, in increments of 10 mm

	Leg to seat surface angle	Leg to seat surface angle	110° (80°)
①	Armrest to seat height	Range: 200 – 280 mm N°1: 200 – 280 mm N°2: 240 mm	Range: 180-285 mm N°1: 195-285 mm N°2: 180 mm
	Front location of armrest structure	190 – 350 mm	N°1: 280 N°2: 380 mm
	Hand rim diameter	535 mm	N/A
	Horizontal location of axle	-55 / +42,5 mm	+50 mm
	Minimum turning radius	790 mm	817 mm
	Stowage width	250 – 320 mm	250 mm
	Stowage height	566 – 1000 mm	705-785 mm
	Stowage length	from 695 – 1130 mm	610 mm
Ⓚ	Overall length without leg rests	655 – 925 mm	770 mm

Ⓛ	Overall height	935 mm	975-1080 mm
	Pivot width	1120 – 1505 mm	1180-1190 mm
	Maximum slope angle brake	7°	7°

(*) The maximum load of the wheelchair is the total of the maximum occupant mass and the maximum mass of any other items intended to be carried by the wheelchair. The maximum occupant mass is the maximum load of the wheelchair without additional load.

E.g.: for a wheelchair with a back pack of 10kg:
Maximum Occupant Mass = Maximum Load of the wheelchair = 10kg

11.2 Maximum Weight of Removable Parts

Part	Maximum weight:
Leg rest angle adjustable with calf pad and footrest	3,2 kg
Armrest	2,0 kg
Rear wheel 600 mm (24") solid with handrim and spoke guard	2,5 kg

Headrest / Neckrest / Cheek support	1,4 kg
Trunk support	0,8 kg
Backrest cushion	2,0 kg
Seat cushion	1,9 kg
Table tray	3,9 kg

11.3 Tyres

The ideal pressure depends on the tyre type:

Tyre	Max. pressure		
Solid tyre: 610 mm (24") — 305 mm (12")	-	-	-
Pneumatic profiled tyre: 610 mm (24")	4.5 bar	450 kPa	65 psi
Solid tyre: 150 mm (6"); 200 mm (8") — 178 mm (7")	-	-	-
Pneumatic tyre: 200 mm (8")	2.5 bar	250 kPa	35 psi

 The compatibility of the tyres listed above depends on the configuration and/or model of your wheelchair.

 In case of a tyre puncture consult a suitable workshop (e.g. bike repair shop, bicycle dealer ...) to have the tube replaced by a skilled person.



The size of the tyre is mentioned on the sidewall of the tyre. The change of appropriate tyres must be carried out by a qualified technician.



CAUTION!

- The tyre pressure has to be equal in both wheels to avoid a less driving comfort, to keep the brakes efficiency and an easy propelling of the wheelchair.

11.4 Materials

Frame/backrest tubes	Aluminum, Steel
Upholstery (seat and backrest)	Foam PUR, Fabric Nylon and Polyester
Push handles	PVC
Plastic parts like brake handles, clothes guards, foot plates, armpads and parts of most options	Thermoplastic (e.g. PA, PP, ABS and PUR) according to marking on the parts
Folding mechanism / vertical brace / clamping parts / castor forks	Aluminum, Steel
Screws, washers and nuts	Steel



All materials used are protected against corrosion. We use only REACH compliant materials and components.



Theft and metal detection systems: in seldom cases the materials used in the wheelchair may activate theft and metal detection systems.

11.5 Environmental conditions

	Storage and transportation	Operation
Temperature	-20 °C to 40 °C	-5 °C to 40 °C
Relative humidity	20 % to 90 % at 30 °C, not condensing	
Atmospheric pressure	800 hPa to 1060 hPa	



Be aware that when a wheelchair has been stored under low temperatures, it must be adjusted to **8.1 Safety Information, page 51**



United Kingdom & Ireland:

Invacare Limited
Pencoed Technology Park, Pencoed
Bridgend CF35 5AQ
Tel: (44) (0) 1656 776 200
uk@invacare.com
www.invacare.co.uk

New Zealand:

Invacare New Zealand Ltd
4 Westfield Place, Mt Wellington 1060
New Zealand
Phone: 0800 468 222
Fax: 0800 807 788
sales@invacare.co.nz
www.invacare.co.nz

Australia:

Invacare Australia Pty. Ltd.
Unit 18/12 Stanton Road,
Seven Hills, NSW 2147,
Australia
Phone: 1800 460 460
Fax: 1800 814 367
orders@invacare.com.au
www.invacare.com.au

Asia:

Invacare Asia Ltd.
Unit 18/12 Stanton Road,
Seven Hills, NSW 2147
Australia
Phone: (61) (02) 8839 5333
Fax: (61) (02) 8839 5343
asiasales@invacare.com
www.invacare.com



Invacare France Operations SAS
Route de St Roch
F-37230 Fondettes
France



Invacare UK Operations Limited
Unit 4, Pencoed Technology Park,
Pencoed Bridgend CF35 5AQ
UK

1608216-G 14-11-2024



Making Life's Experiences Possible®



Yes, you can.®