

Invacare® Action® 4 NG

Action 4 NG Heavy Duty / Action 4 NG Comfort

Rea® Spirea® 4 NG

Spirea 4 NG Heavy Duty

Manual Wheelchair

en User Manual

This manual **MUST** be given to the operator of the product. **BEFORE** using this product, this manual **MUST** be read and saved for future reference.

rea



Yes, you can.®

Contents

1 General	4
1.1 Introduction	4
1.2 Symbols in this Document	4
1.2.1 Other Symbols	4
1.3 Warranty Information	4
1.4 Limitation of Liability	4
1.5 Compliance	4
1.5.1 Product-specific standards	4
1.6 Service Life	4
2 Safety	5
2.1 Safety Information	5
2.2 Safety Devices	6
2.3 Labels and symbols on the product	6
3 Product Overview	8
3.1 Product Description	8
3.2 Intended use	8
3.3 Main parts of the wheelchair	8
3.4 Parking brakes	8
3.5 Backrest	9
3.5.1 Standard Backrest Cover	9
3.5.2 Adjustable Backrest Cover	9
3.5.3 Backrest cover height	9
3.5.4 Fixed backrest	10
3.5.5 Folding backrest	10
3.5.6 Reclining Backrest	10
3.5.7 Angle adjustable backrest	10
3.6 Backbraces	11
3.6.1 Standard backbrace	11
3.6.2 Folding backbrace bar	11
3.6.3 Folding backbrace	12
3.7 Push handles	12
3.7.1 Height adjustable, rear set push handles (optional)	12
3.7.2 Height adjustable, integrated push handles (optional)	12
3.8 Seat	12
3.8.1 Adjusting the seat depth	12
3.8.2 Adjusting the shape of the seat	13
3.8.3 Seat cushion	13
3.9 Mudguard	13
3.10 Armrests	13
3.10.1 Detachable armrests	13
3.10.2 Armrest, stepless height adjustable, removable	14
3.10.3 Armrest, height adjustable, removable	14
3.10.4 Armrest, foldable and removable	14
3.10.5 Armrest, height adjustable, foldable and removable	15
3.11 Leg rests	15
3.11.1 Swing away leg rests	15
3.11.2 Swing away, angle adjustable leg rests	15
3.11.3 Amputee legrest	17
3.11.4 One-piece footrest	17
3.12 Anti-tip device	17
3.12.1 Anti-tip device and ultra low	18
4 Options	19
4.1 Comfort version	19
4.2 Transit version	19
4.3 Dual Handrim DHR	19
4.4 One arm drive by lever OADL	20
4.5 Tipping aid	20
4.6 Headrest / Neckrest	21
4.6.1 Height adjustment	21
4.6.2 Depth / angle adjustment	21
4.7 Table tray	21
4.7.1 Acrylic tray	21
4.7.2 Table tray with mounting kit	21
4.8 Half tray	22
4.8.1 Mounting the half tray	22
4.8.2 Adjusting the half tray	23
4.8.3 Add the half tray cushion	23
4.9 Hemiplegic armrest	23
4.9.1 Lateral positioning pads (for adjustable backrest cover only)	23
4.10 Posture Belt	24
4.11 Oxygen cylinder holder	25
4.12 Drip stand	25
4.13 Air pump	25
4.14 Passive illumination	26
4.15 Cane holder	26
5 Setup	27
5.1 Safety Information	27
5.2 Delivery Check	27
5.3 Unfolding the wheelchair	27
6 Using the wheelchair	28
6.1 Safety Information	28
6.2 Braking	28
6.3 Move to/from the wheelchair	29
6.4 Driving and Steering the Wheelchair	30
6.5 Negotiating steps and kerbs	30
6.6 Going up and down stairs	31
6.7 Negotiating Ramps and Slopes	31
6.8 Stability and balance when seated	32
7 Transport	33
7.1 Safety Information	33
7.2 Folding and unfolding the wheelchair	33
7.3 Lifting the wheelchair	33
7.4 Removing and fitting the rear wheels	33
7.5 Transporting the Manual Wheelchair without Occupant	34
7.6 Transporting the Occupied Wheelchair in a Vehicle	34
8 Maintenance	37
8.1 Safety Information	37
8.2 Maintenance schedule	37
8.3 Cleaning and disinfection	38
8.3.1 General Safety Information	38
8.3.2 Cleaning Intervals	38
8.3.3 Cleaning	38
8.3.4 Cleaning the O2 holder	39
8.3.5 Washing	39

8.3.6 Disinfection	39
9 Troubleshooting	40
9.1 Safety Information	40
9.2 Identifying and repairing faults	40
10 After use	41
10.1 Storage	41
10.2 Disposal	41
10.3 Reconditioning	41
11 Technical data	42
11.1 Dimensions and weight	42
11.2 Maximum Weight of Removable Parts	43
11.3 Tyres	43
11.4 Materials	43
11.5 Environmental conditions	43

1 General

1.1 Introduction

This user manual contains important information about the handling of the product. To ensure safety when using the product, read the user manual carefully and follow the safety instructions.

Only use this product if you have read and understood this manual. Seek additional advice from a healthcare professional who is familiar with your medical condition and clarify any questions regarding the correct use and necessary adjustment with the healthcare professional.

Note that there may be sections in this document, which are not relevant to your product, since this document applies to all available models (on the date of printing). If not otherwise stated, each section in this document refers to all models of the product.

The models and configurations available in your country can be found in the country-specific sales documents.

Invacare reserves the right to alter product specifications without further notice.

Before reading this document, make sure you have the latest version. You find the latest version as a PDF on the Invacare website.

If you find that the font size in the printed document is difficult to read, you can download the PDF version from the website. The PDF can then be scaled on screen to a font size that is more comfortable for you.

For more information about the product, for example product safety notices and product recalls, contact your Invacare distributor. See addresses at the end of this document.

In case of a serious incident with the product, you should inform the manufacturer and the competent authority in your country.

1.2 Symbols in this Document

Symbols and signal words are used in this document and apply to hazards or unsafe practices which could result in personal injury or property damage. See the information below for definitions of the signal words.



WARNING

Indicates a hazardous situation that could result in serious injury or death if it is not avoided.



CAUTION

Indicates a hazardous situation that could result in minor or slight injury if it is not avoided.



NOTICE

Indicates a hazardous situation that could result in damage to property if it is not avoided.



Tips and Recommendations

Gives useful tips, recommendations and information for efficient, trouble-free use.

1.2.1 Other Symbols

(Not applicable for all manuals)



UK Responsible Person

Indicates if a product is not manufactured in the UK.



Triman

Indicates recycling and sorting rules (only relevant for France).

1.3 Warranty Information

We provide a manufacturer's warranty for the product in accordance with our General Terms and Condition of Business in the respective countries.

Warranty claims can only be made through the provider from whom the product was obtained.

1.4 Limitation of Liability

- Non-compliance with the user manual
- Incorrect use
- Natural wear and tear
- Incorrect assembly or set-up by the purchaser or a third party
- Technical modifications
- Unauthorized modifications and/or use of unsuitable spare parts

1.5 Compliance

Quality is fundamental to the company's operation, working within the disciplines of ISO 13485. This product features the CE Mark, in compliance with the Medical Device Regulation 2017/745 Class I. This product features the UKCA mark, in compliance with Part II UK MDR 2002 (as amended) Class I. We are continuously working towards ensuring that the company's impact on the environment, locally and globally, is reduced to a minimum. We only use REACH compliant materials and components.

1.5.1 Product-specific standards

The wheelchair has been tested with dummy of mass equal to the maximum occupant mass, in compliance to EN 12183. It includes testing for flammability. For further information about local standards and regulations, contact your local Invacare representative. See addresses at the end of this document.

1.6 Service Life

The expected service life of this product is five years when used daily and in accordance with the safety instructions, maintenance intervals and correct use, stated in this manual. The effective service life can vary according to frequency and intensity of use. The expected service life may be exceeded if the product is carefully used and properly maintained, and it may be considerably reduced by extreme or incorrect usage.

2 Safety

2.1 Safety Information

This section contains important safety information for the protection of the wheelchair occupant and assistant and for safe, trouble-free use of the wheelchair.



WARNING!

Risk of accidents and serious injury

Accidents with resulting serious injury can occur if the wheelchair is improperly adjusted.

- Contact your wheelchair provider in order to a qualified technician does the adjustments needed.



Invacare expects that the qualified technician is familiar with the product, with good technical knowledge to understand and follow the steps of the described instructions in this manual and equipped with proper tools.



WARNING!

Risk of overturning

The longitudinal position of the rear wheels axis of the wheelchair compared to the backrest position can affect its stability.

- A forwards position makes the wheelchair less stable and increase the risk of tipping backwards, but improves its maneuverability by a better grip position of the handrim and a short turning radius.
- Conversely, by moving the rear wheels axis backwards, the wheelchair is more stable and tilts less easily, but its maneuverability is reduced.
- Depending on the occupant's abilities and its particular safety limits, the decrease in stability can be compensated for by installing an anti-tip device.



WARNING!

Risk of tilting

The rear wheel axle position and the angle of your wheelchair's backrest are two of the key adjustments that can affect your stability.

- The changes of rear/ front wheels position and/ or angle fork adjustments must only be performed by a qualified technician after the assessment of your healthcare professional.



WARNING!

Risk of tipping

The hanging of additional load (back pack or similar items) onto your chair back support tubes can affect the rearward stability of your wheelchair. This can cause the chair to tip backwards causing injury.

- Try to avoid putting additional load in the back of the wheelchair.
- We strongly recommend the use of anti-tip device (available as an option) when using your back support tubes with additional load.



WARNING!

Risk due to driving style being unsuitable for environmental the conditions

- There is a risk of skidding on wet ground, gravel or uneven terrain.
- Always adjust your speed and driving style to the conditions (weather, surface, individual ability, etc).



WARNING!

Risk of injury

In a collision you could sustain injury to parts of your body that extend beyond the wheelchair (e.g. feet or hands).

- Avoid an unbraked collision.
- Never drive into an object head-on.
- Drive carefully through narrow passages.



WARNING!

Risk due to wheelchair being out of control

At high speed you could lose control of your wheelchair and overturn.

- Drive carefully
- Always adapt your speed and your driving style to the conditions (weather, surface, individual ability, etc.).
- Avoid collision.



CAUTION!

Risk of burning

The wheelchair components can heat up when exposed to external sources of heat.

- Do not expose the wheelchair to strong sunlight before use.
- Before use, check all components that come into contact with your skin for their temperature.



WARNING!
Risk of death or serious injury

In case of fire or smoke, wheelchair occupants are at particular risk of death or serious injury, when they are not able to move away from the source of fire or smoke. Lighted matches, lighter and cigarettes can cause an open flame in the wheelchair surroundings or on clothes.

- Avoid using or storing the wheelchair near open flames or combustible products.
- Do not smoke while using the wheelchair.



CAUTION!
Risk of getting parts of body caught

There is always a risk of getting parts of the body e.g. fingers or arms, caught in the moving parts of the wheelchair.

- Take attention while activating and deactivating the mechanisms of moving parts, such as the removable axle of the rear wheel, folding backrest or anti-tip device.



WARNING!
Risk of injury

- In case of pressure sore or injured skin, protect your injuries to avoid a direct contact with the fabrics of the device. Refer to a healthcare professional for medical advice.



CAUTION!
Risk of injury

When combining the wheelchair with another device, the restrictions of both devices apply for the combination. E.g. the maximum occupant mass for the device may be lower.

- Only use combinations with other devices which are allowed by Invacare. Contact your authorized provider for more information.
- Before use, read the user manual of each device and check the restrictions.

2.2 Safety Devices



WARNING!
Risk of accidents

Safety devices that are incorrectly set or no longer working (brakes, anti-tip device) can cause accidents.

- Always check that the safety devices are working before you use the wheelchair and have them checked regularly by a qualified technician.



CAUTION!
Risk of injury

Non-original or wrong parts may affect the function and safety of the product.

- Only use original parts for the product in use.
- Due to regional differences, refer to your local Invacare catalogue or website for available options or contact your Invacare distributor. See addresses at the end of this document.

The functions of the safety devices are described in 3.1 *Product Description, page 8*

2.3 Labels and symbols on the product

Identification label

The identification label is attached to the frame of your wheelchair and gives the following information:

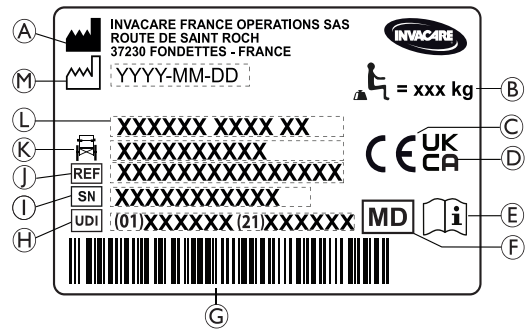

- Ⓐ Manufacturer's name and address
- Ⓑ Maximum load of the wheelchair
- Ⓒ European conformity mark
- Ⓓ United Kingdom conformity mark
- Ⓔ Consult user manual
- Ⓕ Medical device
- Ⓖ UDI barcode
- Ⓗ Unique Device Identifier, with bar code
- Ⓘ Serial Number
- Ⓝ Reference number
- Ⓚ Seat width
- Ⓛ Product name
- Ⓜ Date of manufacture

	Maximum load of the wheelchair or Maximum occupant mass without any additional load
	Consult user manual
	Indicates a hazardous situation that could result in serious injury or death if it is not avoided.

Non-locking side parts warning label

	Do not lift the wheelchair by non-locking side parts.
--	---

Posture belt information label

	Do not lift the wheelchair by non-locking side parts.
--	---

Reclining mechanical backrest information label

	Push on the back support tubes (1) before operating the levers (2), this is to release the auto-locked security system. This label is attached to the upper part of the back support tubes (right side).
--	--

Snap hook symbols

Depending on the configuration, some wheelchairs may be used as a seat in a motor vehicle, some may not.

	Tie-down positions where the restraint system straps must be placed in case of transporting the occupied wheelchair in a motor vehicle. This symbol is only attached to the wheelchair when it is ordered with the transportation kit option.
---	---

	<p>Symbol for wheelchair not intended to be used as a seat in a motor vehicle.</p> <p>This wheelchair is not configured for passenger transport in a motor vehicle. This symbol is attached to the frame close to the identification label.</p> <div data-bbox="181 824 761 1055" style="background-color: #e0e0e0; padding: 5px;"><p>WARNING! Risk of serious injury or death Depending on the configuration, some wheelchairs may be used as a seat in a motor vehicle, some may not.</p><ul style="list-style-type: none">— Do not use the wheelchair for seat in a motor vehicle in.</div>
---	---

3 Product Overview

3.1 Product Description

This is a manual wheelchair with crossbar folding mechanism and swing-away leg rests.

! NOTICE!

The wheelchair is manufactured and configured individually to the specifications in the order. The specification must be performed by a healthcare professional /clinician according to the occupant's requirements and health condition.

- Consult a healthcare professional if you intend to adapt the wheelchair configuration.
- Any adaptation should be performed by a qualified technician.

3.2 Intended use

The medium active wheelchair is intended to provide mobility to persons limited to a sitting position, who are propelling the wheelchair themselves frequently or use the wheelchair for assisted transport.

The wheelchair is intended for persons ages 12 and up (adolescents and adults). The weight of the wheelchair occupant must not exceed the maximum occupant mass as stated in the Technical Data section and on the identification label.

The wheelchair may be used indoors and outdoors on level ground and accessible terrain.

Intended user

The intended user (or operator) is the wheelchair occupant and/ or an assistant. The operator should physically and mentally be able to use the wheelchair safely (e.g. to propel, steer, brake).

Indications

- Considerable to complete impairment of mobility due to structural and/ or functional damage to the lower extremities.
- Sufficient strength and gripping function of arms and hands to propel the wheelchair.

Contraindications

There are no contraindications known, when using the wheelchair as intended.

3.3 Main parts of the wheelchair

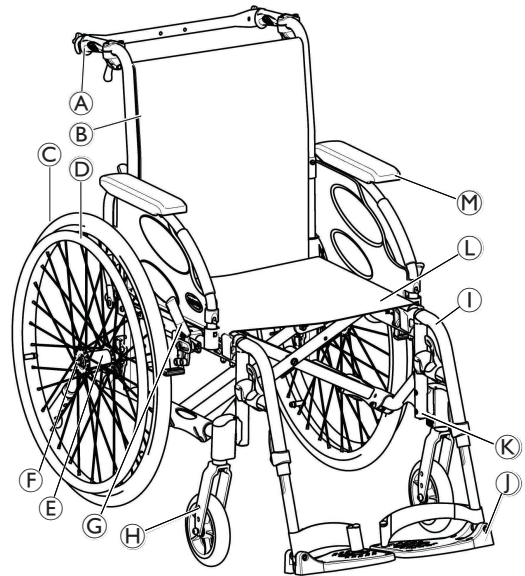

Main parts

Ⓐ	Push handle
Ⓑ	Backrest
Ⓒ	Rear wheel
Ⓓ	Hand rim
Ⓔ	Rear wheel axle
Ⓕ	Rear wheel attachment
Ⓖ	Parking brake
Ⓗ	Castor with its fixation
Ⓘ	Leg rest
⓵	Foot plate
Ⓚ	Frame
Ⓛ	Seat
Ⓜ	Armrest

i The equipment of your wheelchair may differ from the diagram as each wheelchair is manufactured individually to the specifications in the order.

3.4 Parking brakes

The parking brakes are used to immobilize the wheelchair when it is stationary to prevent it from rolling away.

**WARNING!****Risk of overturning if you brake sharply**

If you engage the parking brakes while you are moving, the direction of movement can become uncontrollable and the wheelchair may stop suddenly, which can lead to a collision or to you falling out.

- Never engage the parking brakes while you are moving.

**WARNING!****Risk due to wheelchair being out of control**

- The parking brakes must be operated simultaneously.
- Do not engage the parking brakes to slow down the wheelchair.
- Do not lean on the parking brakes for support or transfer.

**WARNING!****Risk of overturning**

The parking brakes will not operate correctly unless there is sufficient air in the tyres.

- Ensure the correct tyre pressure, 11.3 Tyres, page 62.

**CAUTION!****Risk of pinching or crushing**

There may be a very small gap between the rear wheel or the armrest front socket and the parking brake with the risk that you could trap your fingers.

- Keep your fingers away from movable parts when using the brake, always keep your hand on the brake lever.



The distance between the brake shoe and the tyre can be adjusted. The adjustment must be carried out by a qualified technician.



The lever of the push handle can be folded back to facilitate transfers. To do so, pull up the lever and fold it backwards.

To operate the brake, refer to paragraph *Using the wheelchair, section 6.2 Braking during use, page 29.*

3.5 Backrest

There are three types of backrest (Fixed, Angle adjustable and Reclining) available.

**WARNING!****Risk of injury to the assistant and damage to the wheelchair**

Tilting the chair with a heavy occupant can hurt the assistant's back and damage the chair.

- Make sure to be able to safely control the wheelchair with a heavy occupant before performing a tilting maneuver.

3.5.1 Standard Backrest Cover



A standard backrest cover is available for all backrest types. These covers are not adjustable.

**WARNING!****Risk of tipping**

If the standard backrest cover become slack, the tipping point of your wheelchair is changed for the worse.

- Slack standard backrest cover must be replaced by a qualified technician.

3.5.2 Adjustable Backrest Cover

You can adjust the tension of the backrest cover as required.

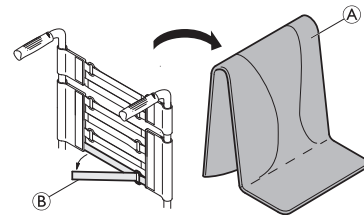

1. Remove the backrest cushion (A).
2. Loosen the hook and loop strips (B) on the rear of the backrest cover by simply pulling on them.
3. Tighten or loosen the strips as required then reattach them.

**WARNING!****Risk of tipping**

If the bands are set very loose, the tipping point of your wheelchair is changed for the worse.

- Ensure that the bands are set correctly.

**NOTICE!**

Do not overtighten the bands; this is to ensure that the geometry of the wheelchair is not changed.

**NOTICE!**

Only ever tighten the bands when the wheelchair is unfolded.

3.5.3 Backrest cover height

The backrest cover height can be adjusted for all backrest types.



WARNING!
Risk of tipping

The hanging of additional load (back pack or similar items) onto your wheelchair back posts can affect the rearward stability of your wheelchair. This can cause the chair to tip backwards causing injury.

- Therefore, Invacare strongly recommend the use of anti-tippers (available as an option) when using your back posts with additional load (back pack or similar items).



The height of the backrest cover can be adjusted on the back support tubes. The adjustment must be carried out by a qualified technician.

3.5.4 Fixed backrest

Fixed backrest of 0° and 7°: these two backrests do not require adjustments.

3.5.5 Folding backrest

To save space for transporting the wheelchair, the backrest can be folded.

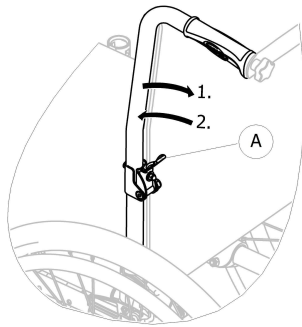

Folding and unfolding the backrest

1. Operate lever **A** by pulling it and fold the top of the backrest.
2. To return to the initial position, bring the top in the vertical position; it locks automatically.

3.5.6 Reclining Backrest

To achieve a more comfort position for occupant, the backrest can be reclined.

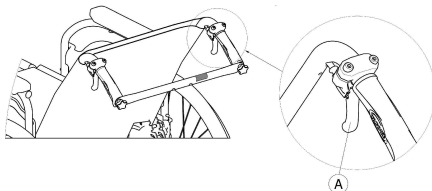

WARNING!
Risk of tipping

The balance of the wheelchair is affected when the backrest is reclined.

- Invacare strongly recommend the use of anti-tip devices (available as an option) when the backrest is in reclined position .

Backrest angle

The angle of the backrest can be adjusted in four steps (0° to 30°) with the mechanical version, and step less with the gas struts version.



CAUTION!
Risk of pinching or crushing fingers

There is always a risk of getting fingers pinched in mechanical parts of the wheelchair.

- Be careful when activating the control levers of the reclining backrest.



CAUTION!
Risk of pinching

- Invacare recommends adjusting the backrest angle before the occupant settles down in the wheelchair to prevent injuries.



Push on the back support tubes before operating the levers, this is to release the auto-locked security system.

1. Release the auto-locked system by pushing on the back support tubes.
2. Simultaneously pull the control levers **A** to provides the same angle on both sides.
3. Release the levers when you reach the desired angle.

3.5.7 Angle adjustable backrest



WARNING!
Risk of tipping

The balance of the wheelchair is affected when the backrest is reclined.

- Invacare strongly recommend the use of anti-tip devices (available as an option) when the backrest is in reclined position.



CAUTION!
Risk of uncomfortable posture

An angle less than 90° between the seat and the backrest is uncomfortable for certain occupants.

- This adjustment must be performed by a qualified technician upon agreement by a clinician. Please consult with your provider.



CAUTION!
Risk of pinching

- Invacare recommends adjusting the backrest angle before the occupant settles down in the wheelchair.

Model -6°/+15°

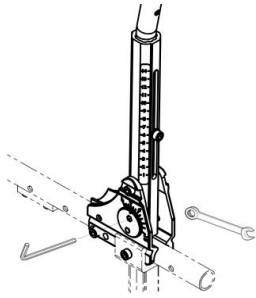

Based on the theoretical 90° between seat and backrest, the angle of the backrest can be adjusted from -6° to +15° (step less).

-  The backrest angle adjustment must be carried out by a qualified technician. Invacare recommends that the adjustment is checked by a clinician according to the occupant's needs.

Model (-15°/+15°)

Based on the theoretical 90° between seat and backrest, the angle of the backrest can be adjusted from -15° to +15° (step less).

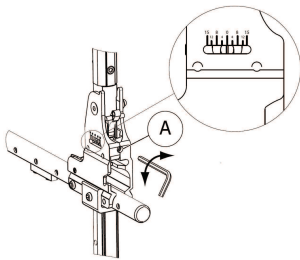

1. Adjust the backrest angle thanks to the adjustable screw **A**.
2. Turn 5 mm Allen key clockwise to obtain a negative angle.
3. Alternatively, turn 5 mm Allen key under clockwise to obtain a positive angle.
4. Ensure both adjustments to the desired angle are equal on both sides.

-  Invacare recommends that the backrest angle adjustment is carried out by a qualified technician. Invacare recommends that the adjustment is checked by a clinician according to the occupant's needs.

3.6 Backbraces

Optional backbraces are available to increase the rigidity of the backrest on wheelchairs. It gives comfort and ease of use of the backrest recline function.



CAUTION!

- Do not use the backbrace to push the wheelchair. The backbrace is not a push bar!
- Do not attempt to lift the wheelchair using the backbrace; it may come loose and it could break.
- Keep your fingers away from movable parts and sharp edges to prevent injuries.

3.6.1 Standard backbrace

The backbrace links the two push handles, provides tension to the backrest upholstery and must always be in position on recliner versions.

Folding the backbrace

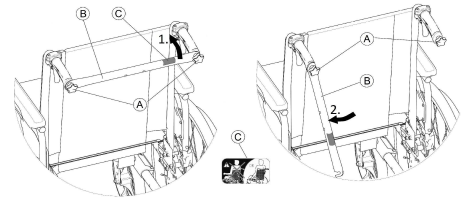

1. Slightly loosen the two hand screws **A**, pull up the backbrace **B** and swivel it downwards along the backrest.
2. Fold the backbrace **B** until it is in vertical position.

Unfolding the backbrace

1. Fold the backbrace **B** upwards.
2. Align the backbrace **B** with the push handle and push it down on the hand screw **A**.
3. Firmly tighten the hand screw **A** and make sure that the TWO hand screws **A** are properly tightened.



It is important to ensure that the backbrace is correctly fitted and engaged at all times when the chair is in use. It should not be left hanging loose (see label **C** on the backbrace).



3.6.2 Folding backrest bar

The folding backrest bar links the two back support tubes and can detach on one side.

Folding the backrest bar

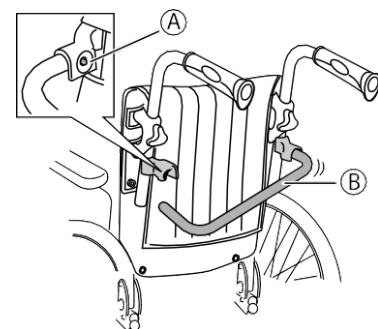

1. Release the spring button **A**.
2. Fold the backrest bar **B** downwards.

Unfolding the backrest bar

1. Unfold the backrest bar **B** upwards until the spring button **A** snaps into its socket hole.
2. Ensure spring button **A** protrudes fully through socket hole.

3.6.3 Folding backbrace

Folding backbrace links to low back support tubes and can be folded on its middle.

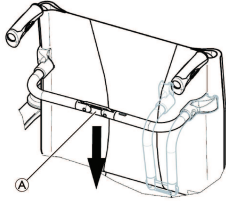

Folding the backbrace

1. Unlock the folding backbrace by pushing the joint (A) slightly downwards.
2. Fold the backbrace downwards.

 The folding backbrace will automatically release when the chair is folded.

Unfolding the backbrace

1. Fold the backbrace upwards.
2. Lock the folding backbrace by pulling the joint (A) slightly upwards.

3.7 Push handles

3.7.1 Height adjustable, rear set push handles (optional)

! NOTICE!
 — Always check the push handles before using the wheelchair, as to whether the hand grips are secure, cannot be turned and cannot be pulled off.

The height adjustable, integrated push handles allow any assistant to adjust the handles to a comfortable level.

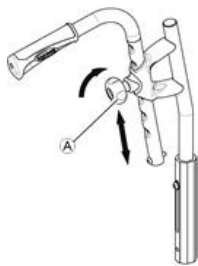

1. To set the height of the push handles, loosen the knob (A), push the handle to the desired position and tighten the knob again.

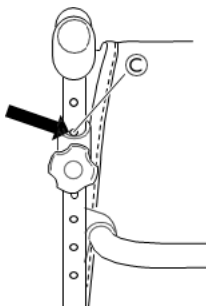

In order to lock the position of the push handle, the nearest upper hole (C) should be visible, just as shown on the picture above.

3.7.2 Height adjustable, integrated push handles (optional)

The height adjustable, integrated push handles allow any assistant to adjust the handles to a comfortable level.

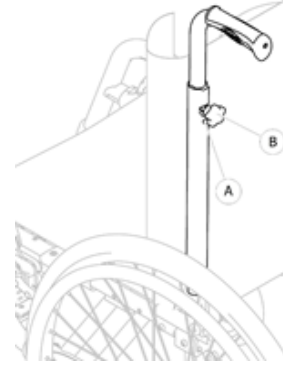

1. To set the height of the push handles, loosen the knob (A), push the handle to the desired position and tighten the knob again.

3.8 Seat

3.8.1 Adjusting the seat depth

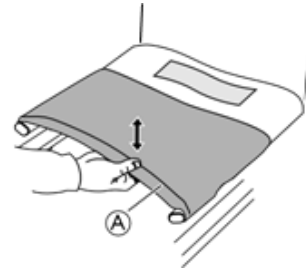

1. Lift the seat (A) upwards in order to fold the chair slightly.
2. Release the front part of the seat (B) from the hook and loop strips.

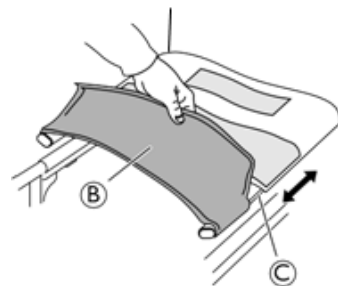

3. Adjust the depth by pulling the sides of the seat forwards or backwards in the rails of the side tubes (C). Make sure that both sides are evenly adjusted.
4. Unfold the chair again.
5. Attach the front part of the seat to the hook and loop strips again.

3.8.2 Adjusting the shape of the seat

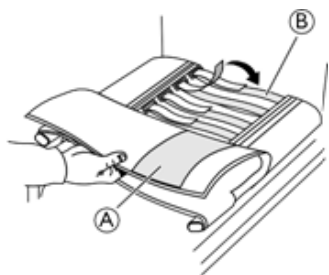

1. Release and pull back the upper section of the seat cover (A).
2. Adjust the hook and loop strips (B) to the desired depth.
3. Fold the seat cover back in place.
Always use a seat cushion when testing the final shape of the seat

3.8.3 Seat cushion

A suitable cushion is recommended to provide an even pressure distribution on the seat.



CAUTION! Risk of instability

Adding a cushion to the seat will raise your height above the ground and can affect your stability in all directions. If a cushion is changed it may also change the occupant's stability.

- If the thickness of the cushion is changed, a complete set up of the wheelchair need to be done by a qualified technician.
- We recommend to use an Invacare or Matrix cushion with anti-slip base cover in order to prevent sliding.

3.9 Mudguard

In order to prevent dirt from the wheels spraying upwards, a removable mudguard can be fitted. The position of the mudguard can be adjusted.

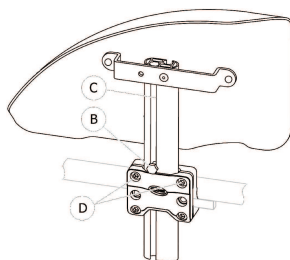

Removing

1. Pull the mudguard upwards out of the holder.
2. To adjust how easy or difficult it is to pull the mudguard out of the holder, change the degree to which the screws (D) are tightened.

Fitting

1. Push the mudguard into the holder.

Adjusting the height

1. Loosen the screw (B) with 10 mm spanner in the groove (C) of the armrest tube.
2. Move the armrest upwards or downwards until you reach the desired height, while keeping screw (B) in place (at the top edge of the holder).
3. Tighten the screw (B) (5–6 Nm).
4. Perform the setting on both sides.

3.10 Armrests



WARNING! Risk of injury

The side rests are not locked and can be easily pulled out upwards

- Do not lift or transfer the wheelchair using the side rests..
- Do not use the side rests for transportation when carrying the wheelchair up- or downstairs.



CAUTION! Risk of pinching

Keep your fingers away from movable parts during removing, fitting or adjusting the armrest.

3.10.1 Detachable armrests

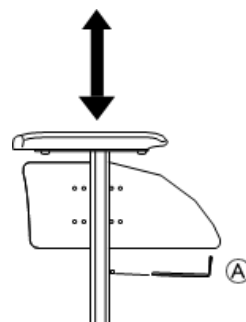

To remove the armrest:

1. Press on the locking mechanism located at the bottom of the armrest vertical bracket.

To fit or adjust the height of the armrest:

1. Loosen the screw (A).
2. Adjust the armrest height to the required position.
3. Re-tighten the screw to the desired height.
4. Repeat the procedure on the opposite side.

 Tools: 5 mm Allen key

3.10.2 Armrest, stepless height adjustable, removable

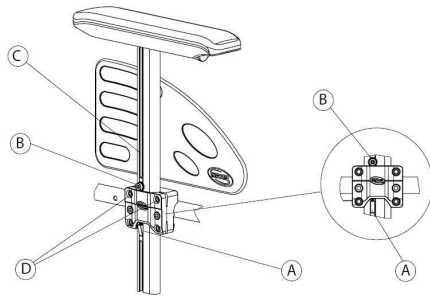

Removing

1. Apply the parking brake on both sides.
2. Previously press on the locking mechanism (A) located at the bottom of the armrest vertical bracket (if so equipped).
3. Pull the armrest by the arm cushion out of the holder.
4. To adjust how easy or difficult it is to pull the armrest out of the holder, change the degree to which the screws (D) are tightened.

Fitting

1. Push the armrest into the holder.

Adjusting the height

1. Loosen the screw (B) with 5 mm Allen key in the groove (C) of the armrest tube.
2. Move the armrest upwards or downwards until you reach the desired height, while keeping screw (B) in place (at the top edge of the holder).
3. Tighten the screw (B) (5–6 Nm).
4. Perform the setting on both sides.

3.10.3 Armrest, height adjustable, removable

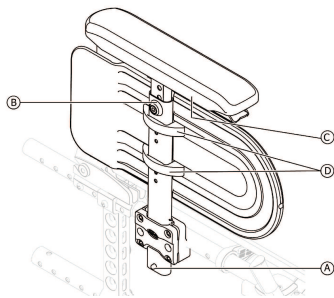

Removing

1. Previously press on the locking mechanism (A) located at the bottom of the armrest vertical bracket (if so equipped).
2. Pull the armrest by the arm cushion out of the holder.

Fitting

1. Push the armrest into the holder.

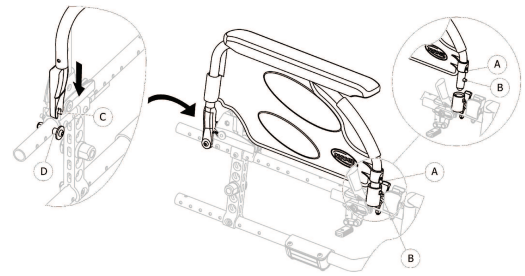

Adjusting the armpad height

1. Loosen the screw (B) with 5 mm Allen key at top of the armrest tube.
2. Move the armrest upwards or downwards until you reach the desired height, while keeping screw (B) in place.
3. Tighten the screw (B) (5–6 Nm).
4. Perform the setting on both sides.

Adjusting the armpad depth

1. Loosen the 2 screws (C) below the armrest bracket.
2. Move the armrest frontwards or rearwards until you reach the desired depth, while keeping screw (C) in place.
3. Tighten the 2 screws C (1,5–2 Nm).
4. Perform the setting on both sides.

Adjusting the side protection height

1. Loosen the 2 screws of the side protection clamps (D).
2. Move the side protection upwards or downwards until you reach the desired height.
3. Tighten the 2 screws of the side protect clamps (D) (0,7–1,2 Nm).
4. Perform the setting on both sides.

3.10.4 Armrest, foldable and removable

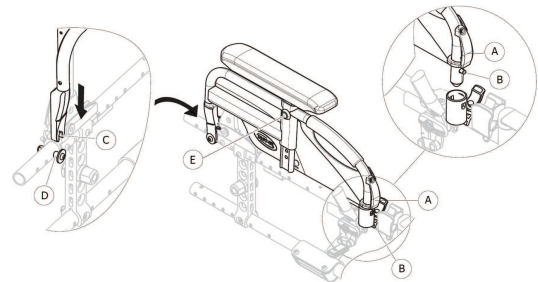

Folding

1. Grip the armrest by the armpad or by the front curve and fold it back.

Front removing

1. Press and hold the armrest release bracket (A) at the front.
2. Remove armrest from armrest socket by pulling straight up and fold it back.

Front fitting

1. Push the armrest down and until the front release button (B) snaps into its armrest socket hole.
2. Ensure button protrudes fully through socket hole.

Rear removing

1. Remove armrest from armrest bracket ④ by pulling straight up on the armrest.

Rear fitting

1. Position armrest support ③ over rear armrest bracket ④.
2. Push the armrest down until a clear “click” is heard when it’s locked into the armrest bracket ④.

3.10.5 Armrest, height adjustable, foldable and removable

Folding

1. Grip the armrest by the armpad or by the front curve and fold it back.

Front removing

1. Press and hold the armrest release bracket ① at the front.
2. Remove armrest from armrest socket by pulling straight up and fold it back.

Front fitting

1. Push the armrest down and until the front release button ② snaps into its armrest socket hole.
2. Ensure button protrudes fully through socket hole.

Rear removing

1. Remove armrest from armrest bracket ④ by pulling straight up on the armrest.

Rear fitting

1. Position armrest support ③ over rear armrest bracket ④.
2. Push the armrest down until a clear “click” is heard when it’s locked into the armrest bracket ④.

Adjusting the height

1. After loosening the fixing screw ⑤ with 5 mm Allen key or alternatively the thumbscrew, if present.
2. Adjust the height and tighten the fixing screw ⑤ (5 Nm) or firmly tighten the thumbscrew, into the desired position.
3. Perform the setting on both sides.

3.11 Leg rests



WARNING! Risk of injury

- Never lift the wheelchair by the footrest supports or leg rests.



CAUTION! Risk of pinching or crushing fingers

- There are swing mechanisms where you could trap your fingers.
- Be careful when using, swinging, disassembling or adjusting these mechanisms.



NOTICE!

Risk of damage to the legrest mechanism or components.

Do not place anything heavy, or let children sit on the leg rest.

3.11.1 Swing away leg rests

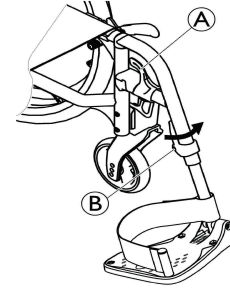

Swing outwards

1. Activate the release lever ① and swing the leg rests to the outside.

Swing forwards

1. Swing the leg rest forwards until it engages.

Unhinging

1. Activate the release lever ①.
2. Pull the leg rest upwards.

Hinging

1. Hinge the leg rest on the front of the frame and swing it forwards until it engages.

3.11.2 Swing away, angle adjustable leg rests

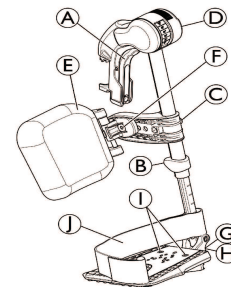

Swinging outwards

1. Activate the release lever ① and swing the leg rests to the outside.

Swinging forwards

1. Swing the leg rest forwards until it engages.

Unhinging

1. Activate the release lever ①.
2. Pull the leg rest upwards.

Hinging

1. Hinge the leg rest on the front of the frame and swing it forwards until it engages.

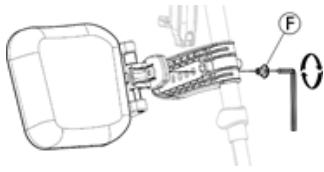

Adjusting angle

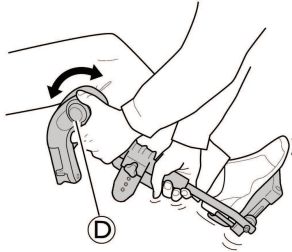

There are six preset positions available for angle adjustment.

1. Loosening the knob **D** and pull it up with one hand while supporting the leg rest with your other hand.
2. Adjust into one of nine preset positions, downwards the knob **D** into the desired position and firmly tighten the knob.

NOTICE!
 Risk of damage to the legrest mechanism or components.

- Ensure free rotation of the knob by supporting enough the legrest with your hand before operating the knob. It will release the auto-locked security system. No rotation effort should be needed to operate the knob.

Swinging calf pad and adjustments

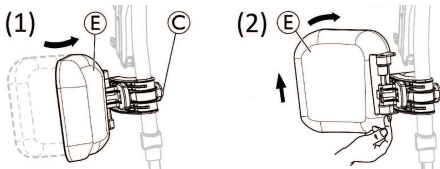

- Swinging calf pad forwards (1) or backwards (2) :
 1. Swing calf pad **E** forwards (1).
 2. Pull up the calf pad **E** and swing it backwards (2).
- Locking the calf pad swing backwards:
 1. Extract the grey spacer open ring **X** out of its location.
 2. Reverse the grey spacer open ring.
 3. Insert the grey spacer open ring **X** as shown on the right side of the diagram.

 Reverse this procedure to unlocking the calf pad swing backwards.

- Adjusting height of calf pad:

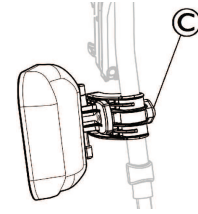

1. Loosen knob **C**.
2. Adjust to the desired height and firmly tighten the knob.

- Adjusting height of calf pad:

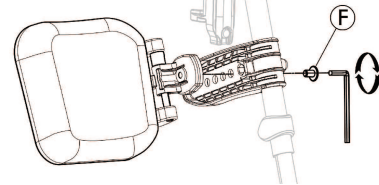

The calf pad has four depth adjustment options:

1. Remove the fixing screw **F** with 5 mm Allen key.
2. Adjust to one of the four positions and firmly tighten the fixing screw **F** (3–5 Nm).

Adjusting foot plate

There are three different fold-up foot plates available.

- Standard height-adjustable foot plates:

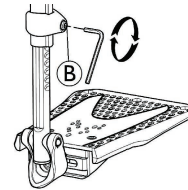

1. Loose the fixing screw **B** with 5 mm Allen key.
2. Adjust the height and let the screw catch one of the recesses on the foot plate tube.
3. Tighten the fixing screw **B** (3–5 Nm) in the desired position.

The distance between the lowest part of the footrest and the ground must be at least 50 mm.

- Depth-, Angle- (1) and Width- (2) adjustable foot plates:

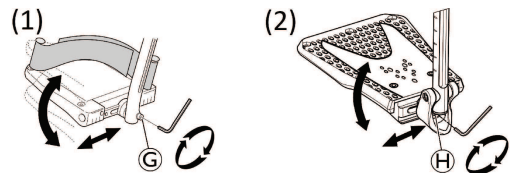

1. Loosen the fixing screw **G** or **H** with 5 mm Allen key.
2. Adjust the depth and angle positions and firmly tighten the fixing screw **G** (12 Nm) or **H** (8–9 Nm) in the desired position.

• **Width-adjustable foot plates (2):**

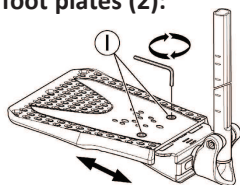

1. Loosen the two fixing screws ① with 5 mm Allen key.
2. Adjust the width position and firmly tighten the two fixing screws ① (3–5 Nm) in the desired position.

Invacare recommends that foot plate adjustment is carried out by a qualified technician.

 To ensure a good position of the feet, two types of straps can be provided; the heel strap ① (serial) and the calf strap (optional) attached to the leg rest support. Both adjustable by hook and loop fasteners.

3.11.3 Amputee legrest



WARNING!

Risk of tipping

There is an increased risk of tipping for amputated users.

- Use anti-tip devices and/or re-balance the wheelchair by moving the rearwheels backwards when amputee legrests are used. Use the passive or the dual amputee rearwheel attachment.

Adjusting the height, depth and angle

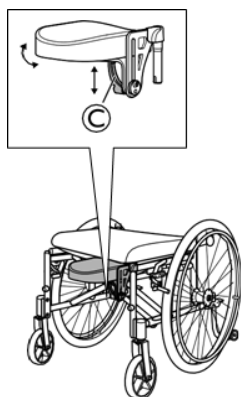

1. Loosen the lever ©.
2. Adjust to the required height, depth and or angle.
3. Re-tighten the lever.

3.11.4 One-piece footrest



WARNING!

Risk of trapping fingers

The fingers might get trapped between the foot plate and the foot plate attachment.

- Be careful not to trap your fingers between the foot plate and the foot plate attachment when folding it down.

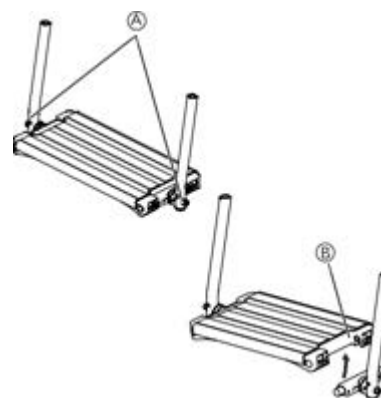

1. Adjust the angle and the depth by loosening the two screws ① at the foot plate attachment.

 Tool: 5 mm allen key

2. Adjust the foot plate to the correct position.
3. Re-tighten the screws with 10 Nm.

 The foot plate can be flipped up. Lift the foot plate ② upwards as shown on the picture above.

 Do not place anything on the foot plate when the screws are loose.

3.12 Anti-tip device

An anti-tip device limits the extent from tipping backwards of the wheelchair.



WARNING!

Risk of overturning

- Anti-tip devices that are incorrectly set or no longer working can lead to overturning.
- Always check that the anti-tip device is working before using the wheelchair and have it set or readjusted by a qualified technician when required.
- In some configurations, the static stability of the wheelchair may be lower than 10°; Invacare strongly recommends the use of anti-tip device (available as an option).



WARNING!

Risk of overturning

On uneven or soft ground, the anti-tip device can sink into potholes or directly into the ground, thereby curtailing or eliminating its safety function.

- Only use the anti-tip device when travelling on even and firm ground.



NOTICE!

Risk of damage

- Never step on the anti-tip device or use it as a tipping aid.



WARNING!
Risk of tipping

An activated anti-tip device can catch when negotiating a step or an edge.

- Always deactivate the anti-tip device before driving over a step or kerb.



WARNING!
Risk of overturning

- Always advise the occupant if you deactivate the anti-tip devices.

Standard anti-tip device with tipping-aid

There is a label on the housing of the anti-tip device, this label shows when the anti-tip device is inactivated. When the anti-tip device is correctly activated, the red label will be concealed.

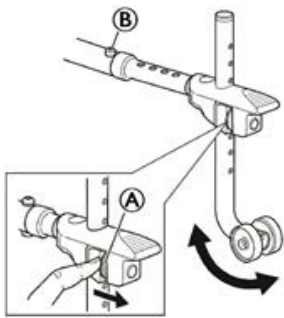

Activating the anti-tip device

1. Release the spring button (A) and swivel the anti-tip device backwards until it engages.
2. Ensure that the anti-tip device is locked correctly.

Deactivating the anti-tip device

1. Release the spring button (A) and swivel the anti-tip device upwards until it engages and the front release button (B) snaps into the frame hole.

Setting the height



WARNING!
Risk of overturning

- The adjustments of the anti-tip device must be carried out by a qualified technician.



This adjustment is required with reference to the position and diameter of the rear wheel as well as the occupant conditions and his particular safety limits



Make sure that the anti-tip device is fitted correctly on each side (if applicable), the spring button (A) and fixation (C) must be locked into position.

3.12.1 Anti-tip device and ultra low

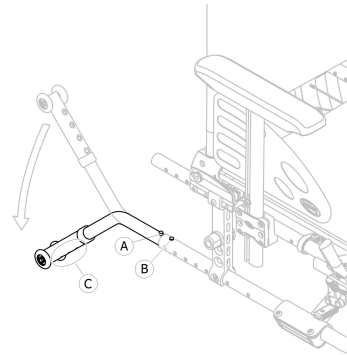

Activating the anti-tip device

1. Release the spring button (A) and swivel the anti-tip device downwards until it engages and the front release button (B) snaps into the frame hole.
2. Ensure front release button (B) protrudes fully through frame hole.

Deactivate the anti-tip device

1. Release the spring button (A) and swivel the anti-tip device upwards until it engages and the front release button (B) snaps into the frame hole.

Setting the height



WARNING!
Risk of overturning

- The adjustments of the anti-tip device must be carried out by a qualified technician.



This adjustment is required with reference to the position and diameter of the rear wheel as well as the occupant conditions and his particular safety limits.



Make sure that the anti-tip device is fitted correctly on each side (if applicable), the spring button (A) and fixation (C) must be locked into position.

4 Options

4.1 Comfort version

It is made up of a rigid shell A and a preformed foam cushion B which is locked in place by hook and loop fasteners. The backrest shell is removable to allow the folding of the wheelchair.

The comfort version is always delivered in passive rear wheel position for a better stability.



WARNING!

Risk of injury

- Never lift the wheelchair by the backrest shell.



CAUTION!

Risk of pinching

Keep your fingers away from movable parts during folding, disassembling or adjustment.

Removing the backrest shell

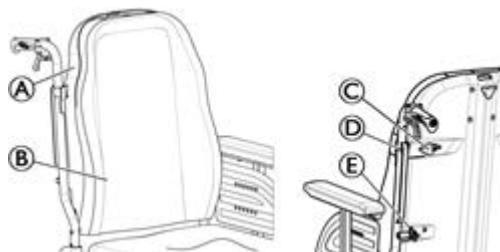

1. Slightly loosen the two hand screws © .
2. Slide the levers © inwards until they are in open position.
3. Disengage the hooks © from their supports.

Installing the backrest shell

1. Engage the hooks © into their supports.
2. Slide the levers © outwards until they are in lock position.
3. Firmly tighten the two hand screws © and make sure that the TWO hand screws © are properly tightened.



It is recommended that this operation be performed only by the assistant. It is important to ensure that the backrest shell is correctly fitted and engaged at all times when the chair is in use. Make sure the backrest cushion hook and loop fasteners are in good state and well positioned.

4.2 Transit version

The transit version is designed to be driven only by the assistant. To facilitate sideways transfers and save space, the wheelchair is equipped with rear wheels of 305 mm (12") or 405 mm (16").

The manual brakes are only accessible to the assistant.



WARNING!

Risk of tipping

The balance of the wheelchair is affected when the backrest is reclined.

- Invacare strongly recommend the use of anti-tip devices (available as an option) for transit version with reclining backrest.

4.3 Dual Handrim DHR

The one arm-drive enables you to move the wheelchair with one hand, which means that two hand rims are installed on the same wheel. You catch both handrims to propel the wheelchair forward or backwards; turn on the LH or RH side by gripping the large or the small handrim only.



The hand rims can either be placed in line with each other (internal position) or with the inner, smaller hand rim outside the larger hand rim (external position). Invacare recommends that smaller hand rim adjustment must be carried out by a qualified technician.



WARNING!

Minor bruises, pain

- Be careful not to trap your fingers between the rear wheel spokes and the three brackets of the outer hand rim when propelling the wheelchair.



WARNING!

Risk of injury

- Always remove the telescopic rear wheel shaft © before removing the rear wheels.

Disengaging and Engaging the Rear Wheel Shaft

To fold the wheelchair it is necessary to disengage the telescopic rear wheel shaft ©.



CAUTION!

Risk of accident

The rear wheel shaft is an integral part of the wheelchair and the occupant will be unable to maneuver the wheelchair without it.

- Never use the wheelchair without the rear wheel shaft.

1. Disengage the telescopic rear wheel shaft © by sliding one part inside the other.
2. To facilitate this operation, move the small handrim forwards to backwards.
3. Reverse procedure to engage the telescopic rear wheel shaft.



The rear wheel shaft can be fitted on either the right or the left side.

Removing and Installing the Rear Wheel

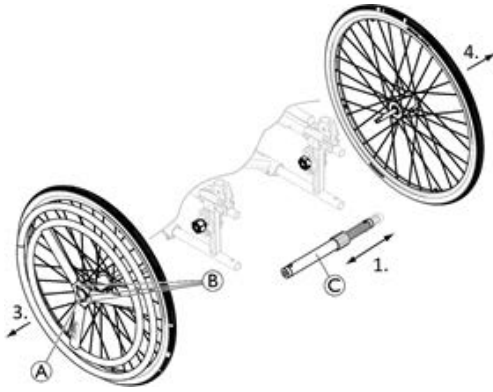

The removable and interchangeable rear wheels facilitate transport as well as change of the control side.



WARNING!
Risk of injury

- Always remove the telescopic rear wheel shaft © before removing the rear wheels.



WARNING!
Risk of injury

- The wheels could come off.
- Check that the rear wheels are securely locked in position! It should not be possible to remove the wheels when the removable axle button A is inactivated. Test this by trying to pull the wheel off.

1. Remove the telescopic rear wheel shaft ©.
2. Press the removable axle button A. Keep it pressed and pull the wheel outwards.
3. Remove the rear wheel.
4. Repeat procedure on the opposite side.
5. Reverse procedure to reinstall the rear wheels.

4.4 One arm drive by lever OADL

The OADL system (left or right hand) allows the operator with low muscular tone to propel the wheelchair with a single arm.



The operator grips the drive motion lever which propels the wheelchair frontwards or backwards (reversing gear lever A, central position is the neutral gear) thanks to an in and out movement; steering is performed by simply turning the drive motion lever to the LH/RH side and braking by pulling the drive motion lever backwards.

The OADL system is always delivered in passive rear wheel position for a better stability.

The drive motion lever can be removed to facilitate transfer or to move next to a table. Loosen the handle lever B and pull up the drive motion lever. Reverse the procedure to reinstall.

The manual brake is always located opposite to the control system.



CAUTION!
Risk of pinching or crushing

- There may be a very small gap between the rear wheel and the transmissions links with the risk that you could trap your fingers.
- Keep your fingers away from movable parts when using the OADL system, always keep your hand on the hand lever.

Adjusting the propulsion effort

The adjustment is performed by moving the transmission links sleeve on the drive motion lever.

1. Slightly loosen the handle lever ©.
2. Slide the transmission links sleeve downwards to reduce the stress.
3. Firmly tighten the handle lever © and make sure that the handle lever © is properly tighten.



CAUTION!
Risk of pinching or crushing

- Make sure that the 2 handle levers B and © are properly positioned so that they are not bothersome or hurtful for the occupant and assistant.

Disengaging the steering mechanism

The assistant can move the wheelchair by disengaging the steering mechanism.

He needs to disengage the ball joint system from the fork in order to release the front directional wheel.

1. Press the end of the disengaging spring D.
2. Release the vertical axle E from its support.
3. Reverse the procedure to reinstall.

4.5 Tipping aid

With the tipping aid, an assistant can tip the wheelchair more easily, in order to navigate steps for example.



WARNING!
Risk of overturning

- Ensure that the tipper aid does not project beyond the external diameter of the rear wheel.

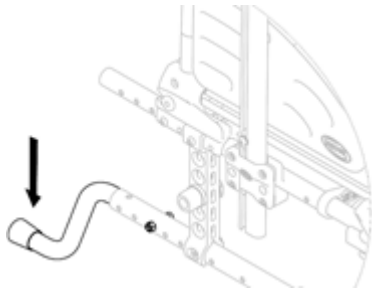

1. Hold the wheelchair by the push handles.
2. Press the tipper aid with your foot and hold the wheelchair in the tipped position until you have overcome the obstacle.

4.6 Headrest / Neckrest



WARNING!

Imbalance of the chair

If the headrest or neckrest is mounted behind the backrest, it may affect the balance of the wheelchair.

- Control the balance of the wheelchair and if necessary, adjust the rearwheels backwards to increase the stability.

4.6.1 Height adjustment

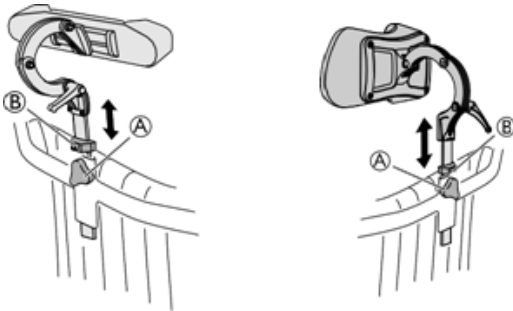

The height and the removal are operated by the handwheel.

The bar is equipped with an adjustable stop block. It allows to remove the headrest/neckrest and reinsert it in the desired position without further adjustments.

1. Loosen the screw in the stop block (B).
2. Loosen the handwheel (A).
3. Adjust the headrest or neckrest to the desired position.
4. Re-tighten the handwheel (A).
5. Slide the stop block (B) down to the top of the headrest/neckrest attachment.
6. Re-tighten the screw.

 Tool: 5mm Allen key

 For information about depth and angle adjustment of the headrest/neckrest and for repositioning of the headrest/neckrest, see the following section.

4.6.2 Depth / angle adjustment

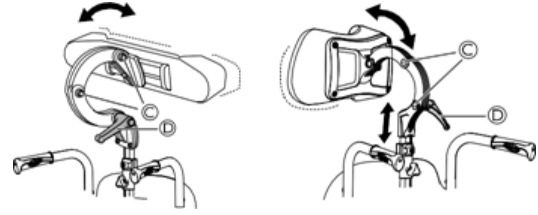

1. Loosen the handle (D).
2. Loosen the screws (C).
3. Adjust the depth and angle of the headrest.
4. Re-tighten the handle and the screws.

4.7 Table tray



WARNING!

Risk of tipping / injury

— Max load on the table: 8 kg.



CAUTION!

Risk of minor injury

If an occupant's elbow protrudes from the table while pushing the wheelchair, he could be bumped by the surroundings.

- Make sure that the elbows of the occupant are not protruding when pushing the wheelchair.

4.7.1 Acrylic tray

Depth adjustment

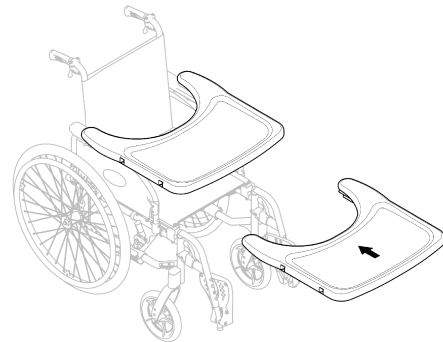

1. Slide the table tray forwards or backwards to adjust to the required depth.



CAUTION!

Risk of discomfort

- When adjusting the depth of the table, make sure not to squeeze the stomach of the occupant.

4.7.2 Table tray with mounting kit



WARNING!

Risk of falling/ injury

- The table must never be used as a replacement for the posture belt.

The table tray can be adjusted both in depth and width, the following sections will show the different possibilities.

Adjusting the depth of the table tray

1. Check that the attachments for table tray are mounted on the armrests. If not, please contact your provider.
2. Open the safety lock for the depth adjustment (A).

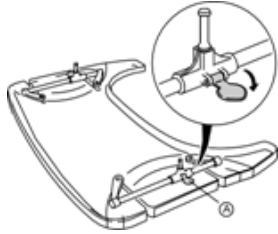

3. Adjust the table holders (B) forwards or backwards to adjust to the required depth.

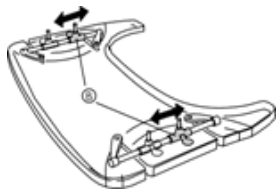

4. Close the table lock (A) again in order to lock the depth position.



CAUTION!

Risk of discomfort / insecurity

The table is not in a fixed position.
 — Make sure to engage the table lock again after adjusting the depth of the table.



CAUTION!

Risk of discomfort

— When adjusting the depth of the table, make sure not to squeeze the stomach of the occupant.

Locking the table tray



WARNING!

Risk of injury

The user is locked in a fixed position and can not be removed from the wheelchair without unlocking the table.
 — The use of locking device for table tray must be prescribed by a clinician.

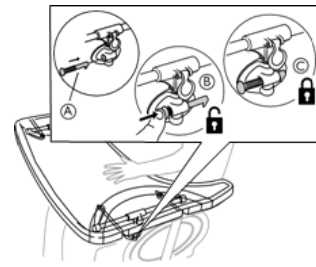

1. Place the locking pin (A) in the table attachment.
2. Press the locking pin (A) inwards to unlock the table (B).
 Keep pressing the locking pin inwards in order to keep the table in an unlocked position.
3. Release the locking pin (A) to lock the position of the table (C).

4.8 Half tray



WARNING!

Risk of falling / injury

— The half tray must never be used as a replacement for the posture belt.



WARNING!

Risk of tipping / injury

— Max load on the tip of the widest part of the half tray: 1.5 kg



CAUTION!

Risk of minor injury

If an occupant's elbow protrudes from the table while pushing the wheelchair, he could be bumped by the surroundings.
 — Make sure that the elbows of the occupant are not protruding when pushing the wheelchair.



CAUTION!

Risk of pinching fingers

There is a mechanism below the half tray where you could trap your fingers..
 — Be careful when adjusting the tray or when using the swing-away function.



CAUTION!

Risk of minor injury

— Do not transfer from the wheelchair when the half tray is in horizontal position.



The half tray can be adjusted in width and swing away.

4.8.1 Mounting the half tray

Mounting the half tray

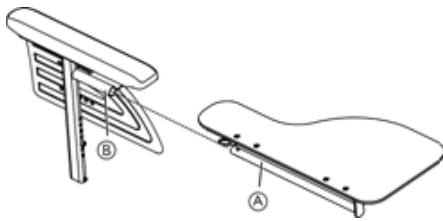

1. Insert the tube of the half tray (A) into the attachment (B) under the arm pad.

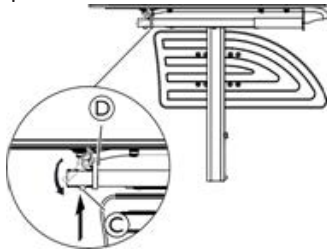

2. Push on the push pin C and insert the ring (D) on the tube (A).
3. Release the push pin (C).

4.8.2 Adjusting the half tray

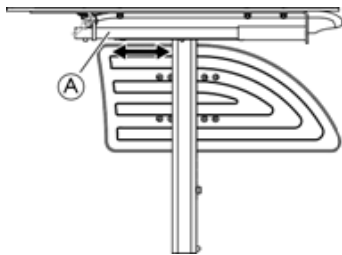

1. Slide the half tray (A) forwards or backwards to adjust to the required depth.



CAUTION! Risk of discomfort

- When adjusting the depth of the half tray, make sure not to squeeze the stomach of the occupant.

4.8.3 Add the half tray cushion

A cushion for the half tray can be placed on the half tray in order to have a softer surface for the arms and elbows.

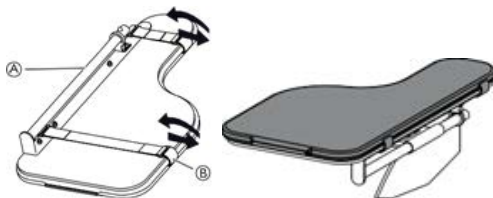

1. Place the cushion for the half tray (A) on the tray.
2. Place the attachment straps (B) into the plastic buckle and around the half tray (A).

4.9 Hemiplegic armrest

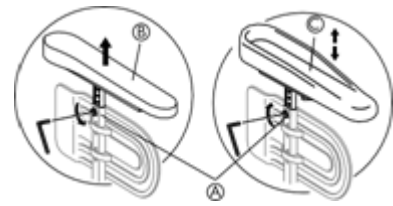

1. Loosen the screw (A).
2. Remove the original armrest (B).
3. Mount the hemiplegic armrest (C) in the armrest pole.
4. Re-tighten the screw (A).

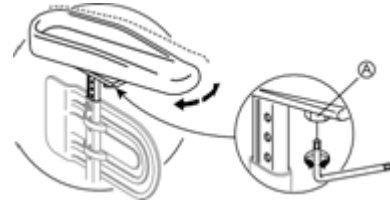

5. The hemiplegic armrest can be adjusted in angle. The resistance can be increased/decreased by adjusting the screw (A).

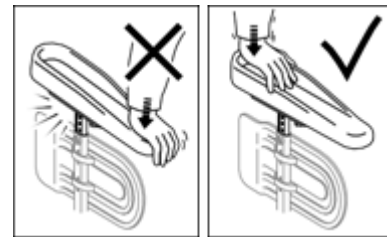

NOTICE!

Risk of damage

Damage on the armrest

- Do not put pressure on the front of the armrest, as this could cause damage on the armrest attachment.

4.9.1 Lateral positioning pads (for adjustable backrest cover only)



CAUTION!

Risk of discomfort

The lateral positioning pads could get into your back instead around your trunk when you get in the wheelchair.

- Check the position of the lateral positioning pads after transferring into the wheelchair.



CAUTION!

Risk of uncomfortable posture

Insufficient space between the lateral positioning pads can be uncomfortable for certain occupants

- This adjustment must be performed by a qualified technician upon agreement by a the prescribing clinician.
- Consult with your provider.

 The lateral positioning pads can be adjusted in height and sideways.

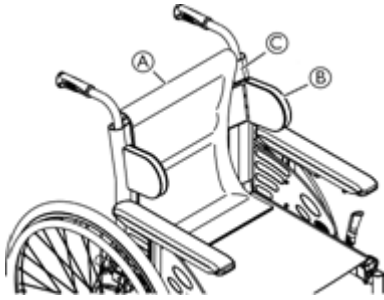

1. Remove the backrest cushion **A**.
2. Adjust the lateral positioning pads **B** in height and sideways to the required position with the hook surface of the backrest cover **C**.
3. Ensure that the two hook surfaces (pads and back cover) are set correctly.
4. Put the backrest cushion **A** back in place.

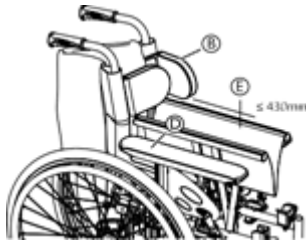

 The lateral positioning pads **B** must be located above the arm pad **D** in order to be able to fold the wheelchair.

 If the seat width is larger than 430 mm **E**, the lateral positioning pads **B** must be removed before folding the wheelchair.

4.10 Posture Belt

The wheelchair can be equipped with a posture belt. It prevents the occupant from sliding downward in the wheelchair or from falling out of the wheelchair. The posture belt is not a positioning device.



WARNING!

A loose belt can cause the user to slip down and create a risk of strangulation.

- The posture belt should be mounted by a qualified technician and fitted by the prescribing clinician.
- Always make sure that the posture belt is tightly fitted across the lower pelvis.
- Each time the posture belt is used, check if it fits properly. Changing the seat and/or backrest angle, the cushion and even your clothes influence the fit of the belt.

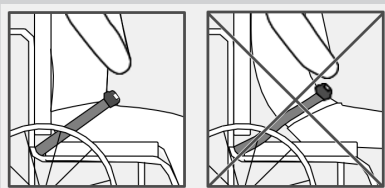

WARNING!

Risk of serious injury during transport

In a vehicle, the wheelchair occupant must be secured by a safety belt (3-point belt). A posture belt only is not sufficient restraint device.

- You can use the posture belt as a complement, but not as a substitute to the 3-point safety belt, when transporting the wheelchair occupant in a vehicle.



NOTICE!

Risk of blocked wheels

- Make sure that the belts do not get caught in the spokes of a rear wheel.

Closing and opening the posture belt

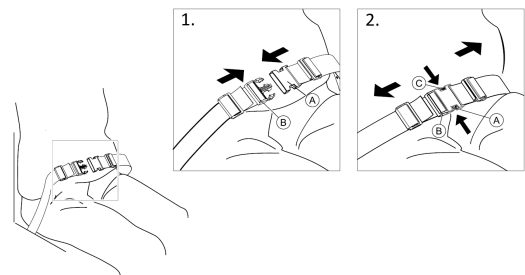

Ensure that you are sitting fully back in the seat and that the pelvis is as upright and symmetrical as possible.

1. To close, push the catch **A** into the buckle clasp **B**.
2. To open, press the sides of the buckle clasp **B** and pull it to separate it from the catch **A**.

Adjusting the length

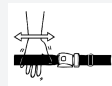

The posture belt has the good length, when there's just sufficient space for a flat hand between body and belt.

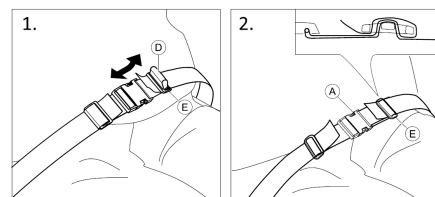

1. Shorten or extend the loop **D** as required.
2. Thread loop **D** through catch **A** and plastic buckle **E** until the loop is flat.
3. Ensure loop **D** is perfectly fitted in plastic buckle **E**.
4. Secure adjustment with the strap extremity fitted again in the buckle **E**.

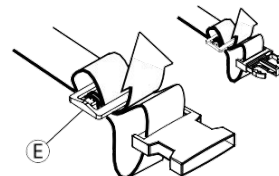

**WARNING!****Risk of sliding below the belt**

- Thread the belt loop 2 times plastic in buckles as indicated to avoid the belt from loosening.

4.11 Oxygen cylinder holder

**WARNING!****Risk of injury and/or damage to the product**

- The installation of the O² holder must be carried out by a qualified technician.
- After any adjustments, repair or service and before use, make sure all attaching hardware is tightened securely.

**WARNING!****Risk of tipping**

The hanging of additional load like O² cylinder onto your wheelchair can affect the rearward stability of your wheelchair. This can cause the chair to tip backwards causing injury.

- We strongly recommend the use of anti-tip devices (available as an option) when using your wheelchair with rear additional load (O² cylinder or similar items).

**WARNING!****Risk of losing the O² cylinder**

If the bands are set very loose, the O² cylinder can fall out of its holder. This can cause the O² cylinder to fall backwards causing injury.

- Ensure that the bands are set correctly.

**NOTICE!**

- Always refer manufacturer's instruction/warning for installation and use of the O² cylinder.

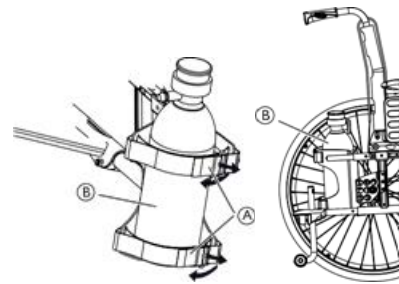
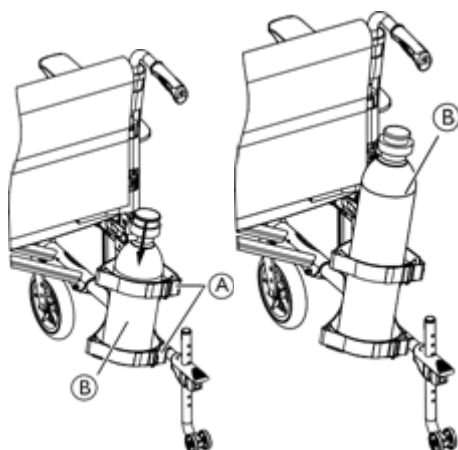

Installing the oxygen bolter in the holder

1. Loosen the hook and loop strips (A) on the rear of the O² holder by simply pulling on them.
2. Insert the O² cylinder (B) into its holder.
3. Tighten or loosen the tapes as required then reattach them.



See section "Technical Data" for information about recommended dimensions of the O² cylinder.

4.12 Drip stand

**WARNING!****Risk of tipping / injury**

- Max load on the drip stand: 4 kg (2 x 2 kg)



The rod of the drip stand must always be placed in a vertical position, i.e in a 90 degree angle to the ground, no matter the position of the backrest or the wheelchair.

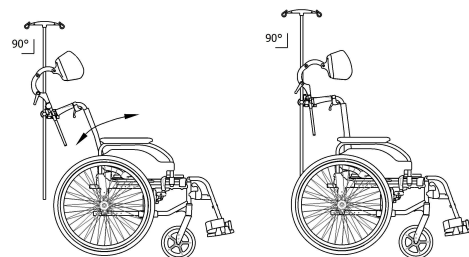

Adjusting the Height and Angle

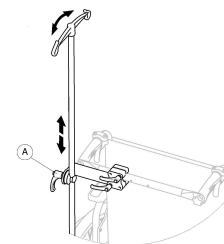

1. Loosen the lever (A).
2. Adjust the drip stand to the desired height or/and angle.
3. Firmly tighten the lever (A).

4.13 Air pump

The air pump is fitted with a universal valve connection. Using the correct valve connection depends of the inner tube valve type.

1. Remove the dust cap from the valve connection.
2. Push the valve connection onto the open valve on the wheel and pump the wheel up.



There are two types of pumps available:

- Low pressure <6 bars
- High pressure >6 bars

Instruction for use printed on the packaging.

4.14 Passive illumination

You can attach reflectors to the rear wheels.

4.15 Cane holder

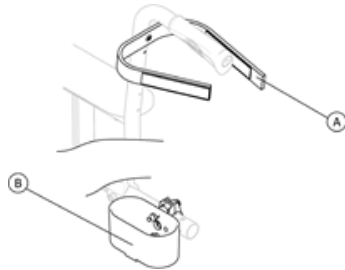

WARNING!

Risk of overturning

– Ensure that the cane holder does not project beyond the external diameter of the rear wheel.

1. Place the cane in the holder ②.
2. Fix the top of the cane to the backrest ①.

5 Setup

5.1 Safety Information



CAUTION!
RISK OF INJURY

- Before using the wheelchair, check its general condition and its main functions, 8.2 Maintenance Schedule, page 52.



WARNING!

- Check all parts for shipping damage before use.
- In case of damage, do not use the device. Contact your Invacare provider for further instructions.



WARNING!

Risk of injury

Poor brake effect

- The cables need to be lined up properly in order to avoid poor brake effect.

Your authorized provider will supply your wheelchair ready for use. Your healthcare professional / clinician will explain the main functions and ensure that the wheelchair meets your needs and requirements.

Some adjustments and settings such as footplate height or anti tip position should be checked before use. Adjustments and settings are described in chapters 3 and 4. Complex modifications are described on the service manual only. Please refer to that information that indicates the competency required to carry out adjustments and any warnings if the stability is affected by these adjustments and settings.

5.2 Delivery Check

Any transport damage must be reported immediately to the transport company. Remember to keep the packaging until the transport company has checked the goods and a settlement has been reached.

5.3 Unfolding the wheelchair

If you receive your wheelchair folded, read section 7.2 Folding and unfolding the wheelchair, page 34.

Line up the cables

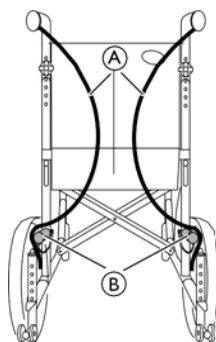

1. Fold the cables **A** inwards as shown on the picture.
2. Place the cables **A** outside of the lower chassis tubes **B**.

6 Using the wheelchair

6.1 Safety Information



WARNING!

Risk of accidents

Uneven tyre pressure can have a huge effect on handling.

- Check the tyre pressure before each journey.



WARNING!

Risk of falling out of the wheelchair

When using small front wheels, the wheelchair could get stuck at curbs or in floor grooves.

- Make sure that the front wheels are suitable for the surface you're driving on.



CAUTION!

Risk of crushing

There may be a very small gap between the rear wheel and the mudguard or armpad with the risk that you could trap your fingers.

- Ensure that you always propel your wheelchair using the handrims only.



CAUTION!

Risk of crushing

There may be a very small gap between the rear wheel and the parking brake with the risk that you could trap your fingers.

- Ensure that you always propel your wheelchair using the handrims only.

6.2 Braking

Whilst you are moving, you brake by transferring force to the handrim with your hands.



WARNING!

Risk of overturning

If you engage the parking brakes while you are moving, the direction of movement can become uncontrollable and the wheelchair may stop suddenly, which can lead to a collision or to you falling out.

- Never engage the parking brakes while you are moving



WARNING!

Risk of falling out of the wheelchair

If the wheelchair is rapidly decelerated by an assistant pulling at the push handles, the occupant may fall out of the wheelchair.

- Always apply the posture belt if present.
- Make sure your assistant is qualified in transferring occupied wheelchairs.
- Operate the two brakes simultaneously and do not take slopes exceeding 7° to ensure perfect control of the wheelchair steering.
- Always use the parking brakes to secure the wheelchair during short or long stops.



CAUTION!

Risk of burning your hands

If you brake for a long time, a lot of frictional heat is produced at the handrims (especially anti slip handrims).

- Wear suitable gloves.

1. Hold the handrims and press evenly with both hands until the wheelchair stops.

Using occupant parking brake



WARNING!

Risk of uncontrolled movement

Right distance between the brake shoe and the tyre is necessary to have an efficient braking effect. This distance can be adjusted. The adjustment must be carried out by a qualified technician.

- Contact with your provider



Standard brake handle

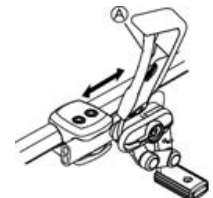

Extended brake handle

Start by checking that the tyres have the correct air pressure (printed on the side of each tyre).

The brake is to be used when the chair is not moving, and is not intended for reducing speed when the chair is moving.

1. To engage the brake, move the lever A towards the rear (towards you).
2. To disengage the brakes, move the lever A forwards.



CAUTION!

Risk of trapping fingers

- Be careful not to trap your fingers between the brake shoe and rear wheel.

Using the One Arm parking Brake

The wheelchair can be equipped with a one arm parking brake instead of the standard occupant parking brake. The one arm brake is operated in the same way as the standard brake, the difference is that the brake handle brakes both wheels at the same time. The one arm brake is available both for the right and the left side of the wheelchair.

Braking with an assistant

With an assistant operated brake (drum brake), an assistant can brake the wheelchair while it is moving. The assistant's brake can also be used as a parking brake.

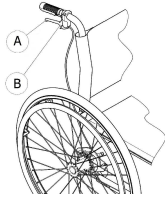

1. To brake, pull the brake lever Ⓐ on the push handle.
2. To park, pull the brake lever firmly and move the safety lever Ⓑ upwards.
3. To release, pull the brake lever until the safety lever disengages.

Braking with an assistant

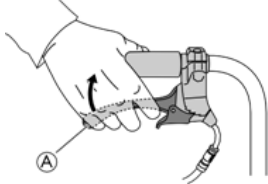

1. Pull both brake handles upwards to engage the brake.

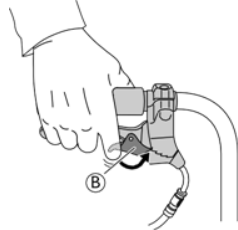

2. Pull the brake handle upwards and push the lock catch Ⓑ downwards to lock the brake.

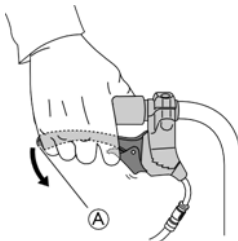

Move the brake handle Ⓐ to release the lock catch.

The lock catch will be released automatically when moving the brake handle.

Using the footbrake

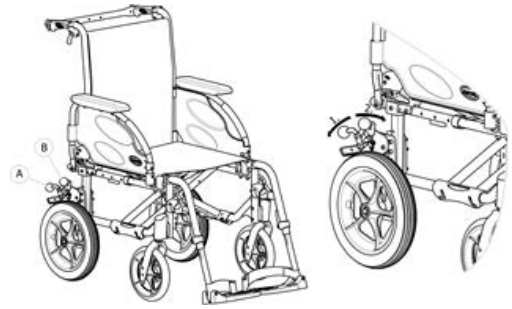

1. To engage the brake, push the brake lever Ⓐ downwards as far as possible.
2. To disengage the brake, pull or push the brake lever Ⓑ upwards.

6.3 Move to/from the wheelchair



WARNING!

Risk of overturning

There is a high risk of overturning during the transfer.

- Only get in and out without assistance if you are physically able to do so.
- When transferring, position yourself as far back as possible in the seat. This will prevent damaged upholstery and the possibility of the wheelchair tipping forward.
- Make sure that both castors are facing straight to the front.



WARNING!

Risk of tipping

The wheelchair could tip forwards if you stand on the footrest.

- Never stand on the footrest when getting in and out.



CAUTION!

If you disengage or damage the brakes the wheelchair could roll away out of control.

- Do not support yourself on the brakes when getting in and out.



NOTICE!

The mudguards and armrests could become damaged.

- Never sit on the mudguards or armrests when getting in and out.



1. Propel the wheelchair as near as possible to the seat that you want to move to.
2. Engage the parking brakes.
3. Remove the armrests or move them upwards out of the way.
4. Detach the leg rests or swing them outwards.
5. Place your feet on the ground.
6. Hold the wheelchair and, if necessary, also hold a fixed object in the vicinity.
7. Move slowly to chair.

6.4 Driving and Steering the Wheelchair

You drive and steer the wheelchair using the handrims. Before driving without an assistant you must find your wheelchair's tipping point.



WARNING! Risk of Tipping

The wheelchair can tip backwards if it is not fitted with an anti-tip device. When finding the tipping point, an assistant must stand immediately behind the wheelchair to catch it if it tips over.

- To prevent tipping, install an anti-tip device



WARNING! Risk of Tipping

The wheelchair can tip forward.

- When setting up your wheelchair, test its behavior in terms of tipping forward and adjust your driving style accordingly.



CAUTION!

A heavy load hanging on the backrest can affect the wheelchair's centre of gravity.

- Avoid heavy load on the backrest. If not possible, change your driving style accordingly.

Finding the Tipping Point

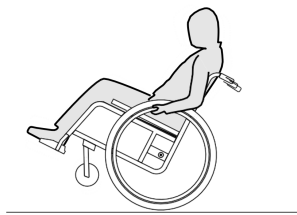

1. Release the brake.
2. Roll backwards a short distance, grasp both handrims firmly and push forwards with a slight kick.
3. The shift in weight and steering in opposite directions with the handrims will enable you to identify the tipping point.

6.5 Negotiating steps and kerbs



WARNING! RISK OF OVERTURNING

When negotiating steps you could lose your balance and tip the wheelchair over.

- Always approach steps and kerbs slowly and carefully.
- Do not go up or down steps that are higher than 25 cm.



CAUTION!

An activated anti-tip device can interfere in steps or kerbs.

- Deactivate the anti-tip device before going up or down steps or kerbs.



WARNING! Risk of injury to the assistant and damage to the wheelchair

Tilting the chair with a heavy occupant can hurt the assistant's back and damage the chair.

- Make sure to be able to safely control the wheelchair with a heavy occupant before performing a tilting maneuver.

Going down a step with an assistant



1. Move the wheelchair right up to the kerb and hold the handrims.
2. The assistant should hold both push handles, place one foot on the tipper aid (if installed) and tilt the wheelchair backwards so that the front wheels lift off the ground.
3. The assistant should then hold the wheelchair in this position, push it carefully down the step and then tilt it forwards until the front wheels are back on the ground.

Going up a step with an assistant



WARNING! Risk of serious injuries

Going up steps and kerbs frequently might result in fatigue break of the wheelchair backrest and falling of the occupant.

- Always negotiate steps and kerbs slowly and carefully.



You can use a tipper aid when going up steps or kerbs.

1. Move the wheelchair backwards until the rear wheels touch the kerb.

- The assistant should tilt the wheelchair using both push handles so that the front wheels lift off the ground, then pull the rear wheels over the kerb until the front wheels can be placed back on the ground.

Going down a step without an assistant

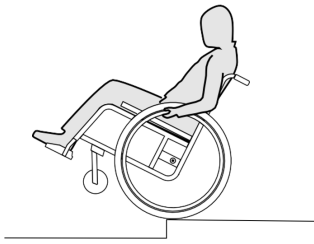

WARNING! Risk of tipping

When going down a step without an assistant you could tip over if you cannot control your wheelchair.

- First learn how to go down a step with an assistant.
- Learn how finding the tipping point to balance on the rear wheels, 6.4 Driving and Steering the Wheelchair, page 38.

- Move the wheelchair right to the kerb, lift the front wheels and keep the wheelchair balanced.
- Now slowly roll both rear wheels over the kerb. While doing this, hold the handrims firmly with both hands until the front wheels are back on the ground.

6.6 Going up and down stairs



WARNING! Risk of overturning

When negotiating stairs you could lose your balance and overturn your wheelchair.

- Always use two assistants when negotiating stairs with more than one step.



- You can go up and down stairs by taking them one step at a time, as described above. The first assistant should stand behind the wheelchair holding the push handles. The second assistant should hold a solid part of the front frame to steady the wheelchair from the front.

6.7 Negotiating Ramps and Slopes



WARNING!

Risk due to wheelchair being out of control

When negotiating slopes or gradients your wheelchair could tip backwards, forwards or sideways.

- Always have an assistant behind the wheelchair when approaching long slopes.
- Avoid lateral slopes.
- Avoid slopes of more than 7°.
- Avoid jerking when changing direction on a slope.



CAUTION!

Your wheelchair could run away even on slightly sloping ground if you do not control it using the handrims.

- Use the parking brakes if your wheelchair is stationary on sloping ground.

Going up slopes

To go up a slope, you must create some momentum, keep up the momentum and control the direction at the same time.

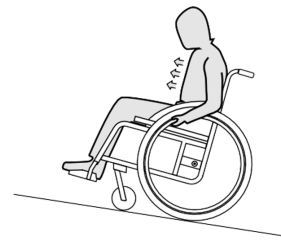

- Bend your upper body forwards and propel the wheelchair with quick, powerful strokes on both handrims.

Going down slopes

When going down slopes, it is important to control your direction and particularly your speed.

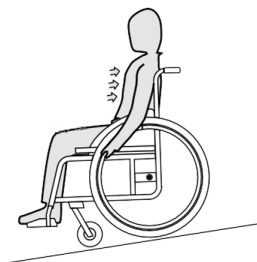

- Lean back and carefully allow the handrims to run through your hands. You should be able to stop the wheelchair at any time by gripping the handrims.



CAUTION!

Risk of burning your hands.

If you brake for a long time, a lot of frictional heat is produced at the handrims (especially anti slip handrims).

- Wear suitable gloves.

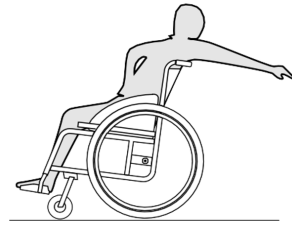

6.8 Stability and balance when seated



WARNING!

Risk of tipping

The hanging of additional load (back pack or similar items) onto your wheelchair back support tubes can affect the rearward stability of your wheelchair. This can cause the chair to tip backwards causing injury.

- Therefore, Invacare strongly recommend the use of anti-tip devices (available as an option) when using your back support tubes with additional load (back pack or similar items).

1. Point the front wheels forwards. (To do this, move your wheelchair forwards slightly then back again.)
2. Do not apply the parking brakes.
3. When reaching backwards do not reach so far that you have to change your sitting position.

Some everyday activities and actions require you to lean forwards, sideways or backwards out of the wheelchair. This has a major effect on the wheelchair's stability. To keep your balance at all times, proceed as follows:

Leaning forwards



WARNING!

Risk of falling out

If you lean forwards out of the wheelchair you could fall out of it.

- Never bend too far forwards and do not shift forwards in your seat to reach an object.
- Do not bend forwards between your knees to pick up something off the floor.

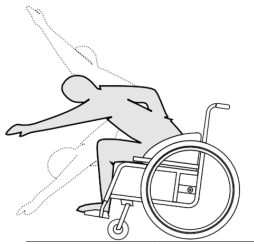

1. Point the front wheels forwards. (To do this, move your wheelchair forwards slightly then back again.)
2. Apply both parking brakes.
3. When leaning forwards your upper body must remain over the front wheels.

Reaching backwards



WARNING!

Risk of falling

If you lean too far backwards you could tip your wheelchair over.

- Do not lean out over the backrest.
- Use an anti-tip device.

7 Transport

7.1 Safety Information



WARNING!

Risk of injury if the wheelchair is not properly secured

In the event of an accident, braking manoeuvre, etc. you may suffer serious injuries from flying wheelchair parts.

- Always remove the rear wheels when transporting the wheelchair.
- Firmly secure all wheelchair components in the means of transport to prevent them from coming loose during the journey.



NOTICE!

Excessive wear and abrasion could affect the strength of load-bearing parts.

- Do not pull your wheelchair across abrasive surfaces without the wheels fitted (e.g. pulling the frame over tarmac).

7.2 Folding and unfolding the wheelchair

Folding the wheelchair

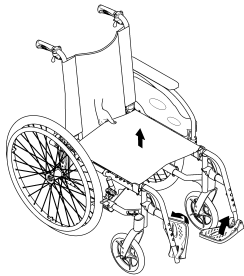

1. Remove the seat cushion, if present.
2. Fold the backbrace, if present.
3. Fold the foot plates upwards.
4. Pull the seat cover upwards.
5. You can fold the backrest frontwards, if your wheelchair is fitted with an angle adjustable and fold down backrest.
6. Pull the pull-cord upwards at the back of the wheelchair. The angle adjustable and fold down backrest folds forwards.

Unfolding the wheelchair

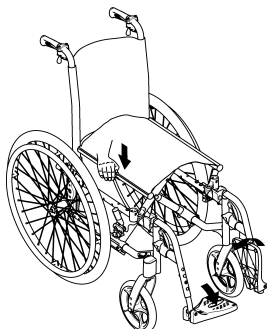

CAUTION!

Risk of getting fingers caught

There is a risk of getting your fingers caught between the seat edge and the frame.

- Never clasp the seat edge with your fingers.

1. Position the wheelchair next to you.
2. Tilt the wheelchair, if possible, gently towards you.
3. With your hand flat, press the seat edge closest to you, so that the seat surface flattens out.
4. Put the wheelchair back completely on the floor and check that the seat edges on both sides are in the guide components.
5. If your wheelchair is fitted with an angle adjustable and fold down backrest, pull up the backrest at the push-handles until the ratchet bolts engage in the lateral supports.
6. Fold the foot plates down.
7. Unfolding the backbrace, if present.

7.3 Lifting the wheelchair



NOTICE!

- Never lift the wheelchair by removable parts (armrests, footrests, backrest bar).
- Ensure the back support tubes are securely in place.

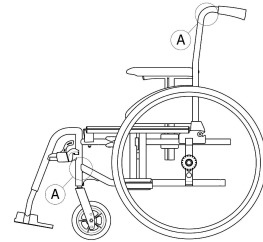

1. Fold the wheelchair, see chapter 7.2 Folding and unfolding the wheelchair, page 44.
2. Always lift the wheelchair by gripping the frame at points A.

7.4 Removing and fitting the rear wheels



WARNING!



Risk of overturning

If the removable axle of a rear wheel is not fully engaged, the wheel can become loose during use. This can lead to overturning.

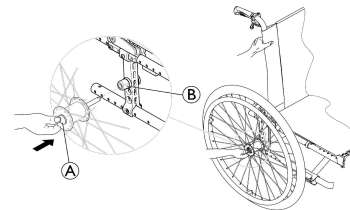
- Always ensure that the removable axles are fully engaged whenever you fit a wheel.



Removing the rear wheels

1. Release the brakes.
2. With one hand, hold the wheelchair upright.
3. With the other, hold the wheel through the external spoke rim around the wheel hub.
4. Using your thumb, press the removable axle button . Keep it pressed and pull the wheel out of the adapter sleeve .

Fitting the rear wheels

1. Release the brakes.
2. With one hand, hold the wheelchair upright.
3. With the other, hold the wheel through the external spoke rim around the wheel hub.
4. Using your thumb, press the removable axle button and hold it down.
5. Push the axle into the adapter sleeve  up to the stop.
6. Release the removable axle button and make sure that the wheel is secure.

7.5 Transporting the Manual Wheelchair without Occupant



CAUTION!

Risk of burning your hands

If you brake for a long time, a lot of frictional heat is produced at the handrims (especially anti slip handrims).

- Wear suitable gloves.

Your mobility device may be transported without restrictions, whether by road, rail or by air. Individual transport companies have, however, guidelines which can possibly restrict or forbid certain transport procedures. Please ask the transport company regarding each individual case.



Invacare strongly recommends securing the manual wheelchair to the floor of the transporting vehicle.



CAUTION!

Risk of injury

- If you are unable to fasten your mobility device securely in a transport vehicle, Invacare recommends that you do not transport it.



You can remove some components from the wheelchair as armrests, footrests and rear wheels and fold it. This way, your wheelchair will be easier to transport.

7.6 Transporting the Occupied Wheelchair in a Vehicle

Even when the wheelchair is properly secured and the following rules are met, injuries to passengers may occur in a collision or sudden stop. Therefore Invacare strongly recommends transferring the wheelchair occupant to the vehicle seat with the 3-point passenger restraint system on. Do not make alterations or substitutions to points of the wheelchair (structure, frame or parts) without the written consent of Invacare Corporation. The wheelchair has been successfully tested according to the requirements of ISO 7176-19 (Frontal impact).



WARNING!

Risk of serious injury or death

To use the wheelchair as a seat in a vehicle the backrest height minimum must be at least 400 mm.

To transport the wheelchair with occupant in a vehicle, a restraint system must be installed in the vehicle. Wheelchair tie-downs and occupant restraint systems must be approved according to ISO 10542-1. Contact your local Invacare authorized provider for more information on getting and installing an approved and compatible restraint system.



WARNING!

If, for some reason, it is impossible to transfer the wheelchair occupant to a vehicle seat, the wheelchair can be used as a seat in a vehicle if the following procedures and regulations are followed. A transportation kit (optional) must be fitted on the chair for such a purpose.

- The wheelchair must be secured in the vehicle with a 4-point wheelchair restraint system.
- The occupant must wear a 3-point passenger restraint system secured to the vehicle.
- The occupant can be additionally secured with a posture belt in the wheelchair.



WARNING!

Safety restraint devices must only be used when the wheelchair user's weight is 22 kg or more (ISO-7176-19).

- Do not use the wheelchair as a seat in a vehicle when the occupant weight is lower than 22 kg.



WARNING!

- Before journey contact transporter and request information about the capability for the below required equipment.
- Make sure there is sufficient free space around the wheelchair and the occupant to avoid the contact of the occupant with other vehicle occupants, unpadded parts of the vehicle, wheelchair options or anchor points of the restraint system.

**WARNING!**

- Make sure the tie-down points at the wheelchair are not damaged and that the parking brakes are fully functional.
- It's recommended to use puncture-proof tyres during transport to avoid brake problems due to reduced tyre pressure.

**WARNING!**

- Injury or damage may occur from wheelchair components or options loosened during a collision or sudden stop.
- Table tray, drip stand, crutch, or any additional load you may have had on your wheelchair should be removed from the wheelchair and stowed safely.
 - It is essential to have your wheelchair checked by a qualified technician after an accident, collision etc..

Ramps and Slopes:**WARNING!****Risk of injury**

- The wheelchair can move forward / backward uncontrollably by mistake.
- Never leave the user unattended when transporting the wheelchair up or down ramps or slopes.



Therefore Invacare strongly recommends transferring the wheelchair occupant to the vehicle with the posture belt on.

**NOTICE!**

- Refer to the user manuals supplied with the restraint systems.
- The following illustrations may differ depending on the restraint system supplier.

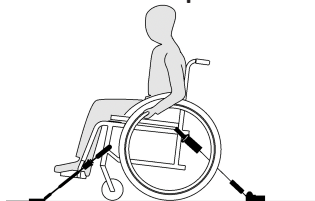

The choice of wheelchair configuration (seat width and depth, wheelbase) influences maneuverability and access to motor vehicles.

Securing the wheelchair with a 4-point restraint system**WARNING!**

- Place the wheelchair with the occupant forward-facing in direction of vehicle travel.
- Engage the wheelchair parking brakes.
- Activate anti-tipper (if installed).



Ensure that tray, drip stand, and any additional load you may have had on your wheelchair are removed from the wheelchair and stored securely in the vehicle.

The wheelchair tie-down positions where the 4-point restraint system straps must be placed are marked with snap hook symbols (see following figures and section 2.3 Labels and symbols on the product, page 9).

1. Using the front and rear straps of the 4-point restraint system, secure the wheelchair to the vehicle mounted rails. Refer to the user manual supplied with 4-point restraint system.

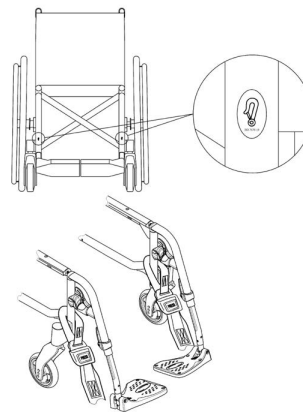
Front side tie-down positions for belt straps:

1. Attach the front straps above the castor supporters as shown in the figure above (see location of the attachment labels).
2. Attach front straps to the rail system referring to best practice recommended instructions from the 4-point restraint system manufacturer.
3. Disengage parking brakes and apply tension front straps by pulling the wheelchair backwards from the rear.
4. Re-engage parking brakes.

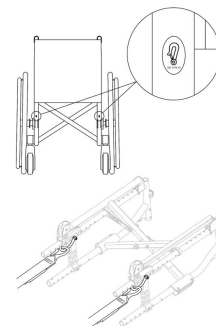
Rear side tie-down positions for snap hooks:

1. Attach the snap hooks to the orange rings as shown in the two figures above (see location of the attachment labels).
2. Attach rear straps to the rail system referring to best practice recommended instructions from the 4-point restraint system manufacturer.
3. Tighten the straps.

**NOTICE!**

- Make sure that the snap hooks are covered with slip resistant material to avoid laterally slipping on the axle.

! NOTICE!

- Check the plungers are fully engaged on both sides and located in the same position of the cut-out section of the rail.
- Make sure that the angle between the rails and the straps lies between 40° and 45°.

Fit posture belt



WARNING!

The posture belt can be used in addition to but never as a substitute for an approved passenger restraint system (3-point belt).

1. Adjust posture belt to fit the wheelchair occupant, see section Posture Belt.

Fastening the 3-point passenger restraint system

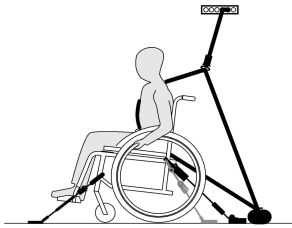

! NOTICE!

The illustration above may differ depending on the restraint system supplier.



WARNING!

- Ensure the 3-point passenger restraint system fits as tightly across the occupant's body as possible without discomfort and no part is twisted.
- Ensure the 3-point passenger restraint system is not held away from the occupant's body by parts of the wheelchair such as armrests or wheels etc.
- Ensure the occupant restraint has a clear path from the occupant to the anchor point without interference by any part of the vehicle, wheelchair, seating or accessory.
- Ensure the lap belt fits snugly over the occupant's pelvis and is not allowed to ride up into the abdominal area.
- Ensure the user is able to reach the release mechanism unaided.



1. Attach the 3-point passenger restraint system referring to the user manual supplied with your 3-point restraint system. The 3-point belt restraint should fit as tightly across the occupant's body as possible without discomfort.



NOTICE!

- Ensure that the belt webbing is not twisted when in use.



NOTICE!

- Apply the pelvic belt restraint of the 3-point belt restraint system low across the pelvis so that the angle of the pelvic belt is within the preferred zone (A) of 30° to 75° to the horizontal. A steeper angle is preferred, but never exceeding 75°.

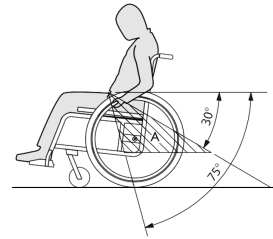

The image shows an incorrect placement of three-point belt restraint.

2. The belt restraint must not be held away from the user's body by parts of the wheelchair such as armrests or wheels etc.
3. If the vehicle is equipped with a head restraint and the wheelchair with the head/neck support, then assess with a clinician which one should be used.



The Invacare head and neck supports are not restraint devices. Nevertheless, they have been crash tested to verify their attachment points.

8 Maintenance

8.1 Safety Information



WARNING!

Some materials deteriorate naturally over time. This could result in damage to wheelchair components.

- Your wheelchair should be checked by a qualified technician at least once a year or if it has not been used for a long period.



Invacare expects that the qualified technician is familiar with the product, with good technical knowledge to understand and follow the steps of the described instructions in this manual, and equipped with proper tools.



Packaging for return

The wheelchair shall be sent to the authorized provider in an appropriate packaging to avoid damage during the shipment.

8.2 Maintenance schedule

To ensure safe and reliable operation, carry out the following visual checks and maintenance regularly or have it carried out by another person

	weekly	monthly	annually
Check the tyre pressure	x		
Check that rear wheels are seated correctly	x		
Check posture belt	x		
Check the folding mechanism		x	
Check the castors and its fixation		x	
Check bolts		x	
Check spokes		x	
Check parking brakes (mechanism and cable)		x	
Have wheelchair checked by a qualified technician			x

General visual check

1. Examine your wheelchair for loose parts, cracks or other defects.
2. If you find anything, stop using your wheelchair immediately and contact an authorized provider.

Check the tyre pressure

1. Check the tyre pressure, see section "Tyres" for more information.
2. Inflate the tyres to the required pressure.
3. Check the tyre tread at the same time.
4. If necessary, change the tyres.

Check that rear wheels are seated correctly

1. Ensure that the axle ball is outside its receiver by visually checking it and pull on the rear wheel to check that the removable axle is seated correctly. The wheel should not come off.
2. If the rear wheels are not engaged properly, remove any dirt or deposits. If the problem persists, have the removable axles re-fitted by a qualified technician.

Check posture belt

1. Check that the posture belt is adjusted correctly.



NOTICE!

- Loose posture belts must be adjusted by an authorized clinician.
- Damaged posture belts must be replaced by a qualified technician.

Check the folding mechanism

1. Check that the folding mechanism is easy operating.

Check the castors and its fixation

1. Check that the castors turn freely.
2. Push and pull in the 3 directions (front and rear; left and right; up and down) to observe that there is no free play and movement, also check that there is no visual damage.

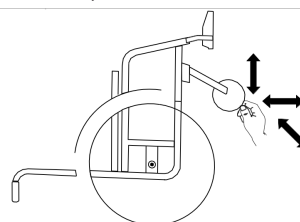

3. Remove any dirt or hair from the castor bearings.
4. Faulty or worn out castors must be replaced by a qualified technician.



NOTICE!

- Self-locking screws/nuts or thread-locking adhesive are used for several connections. If these are loosened, they must be replaced by new self-locking screws/nuts or they must be secured using new thread-locking adhesive.
- Self-locking screws/nuts must be replaced by a qualified technician

Check the spoke tension

The spokes should not be loose or distorted.

1. Loose spokes must be tightened by a qualified technician.
2. Broken spokes must be replaced by a qualified technician.

Check the parking brakes

1. Check that the parking brakes are positioned correctly. The brake is set correctly if the brake shoe depresses the tyre by a few millimeters when the brake is engaged.
2. If you find that the setting is not correct, have the brakes correctly adjusted by a qualified technician.

! NOTICE!
The parking brakes must be reset after replacing the rear wheels or changing their position.

Checking after a heavy collision or blow

! NOTICE!
The wheelchair can sustain visibly undetectable damage as a result of a heavy collision or hard blow.

- It is essential to have your wheelchair checked by a qualified technician after a heavy collision or hard blow.

Repairing or changing an inner tube

1. Remove the rear wheel and release any air from the inner tube.
2. Lift one tyre wall away from the rim using a bicycle tyre lever. Do not use sharp objects such as a screwdriver which could damage the inner tube.
3. Pull the inner tube out of the tyre.
4. Repair the inner tube using a bicycle repair kit or, if necessary, replace the tube.
5. Inflate the tube slightly until it becomes round.
6. Insert the valve into the valve hole on the rim and place the tube inside the tyre (the tube should lie right round the tyre with no creases).
7. Lift the tyre wall over the edge of the rim. Start close to the valve and use a bicycle tyre lever. When doing this, check all the way round to ensure that the inner tube is not trapped between the tyre and the rim.
8. Inflate the tyre to the maximum operating pressure. Check that no air is escaping from the tyre.

i Spare parts
Invacare strongly recommends using spare parts supplied by invacare for the maintenance of the products.

8.3 Cleaning and disinfection

8.3.1 General Safety Information

! CAUTION!
Risk of Contamination
— Take precautions for yourself and use appropriate protective equipment.

! NOTICE!
Wrong fluids or methods can harm or damage the product.

- All cleaning agents and disinfectants used must be effective, compatible with one another and must protect the materials they are used to clean.
- Never use corrosive fluids (alkalines, acid etc.) or abrasive cleaning agents. We recommend an ordinary household cleaning agent such as dishwashing liquid, if not specified otherwise in the cleaning instructions.
- Never use a solvent (cellulose thinner, acetone etc.) that changes the structure of the plastic or dissolves the attached labels.
- Always make sure that the product is completely dried before taking it into use again.

i For cleaning and disinfection in clinical or long-term care environments, follow your in-house procedures.

8.3.2 Cleaning Intervals

! NOTICE!
Regular cleaning and disinfection enhance smooth operation, increases the service life and prevents contamination.
Clean and disinfect the product:

- regularly while in use,
- before and after any service procedure,
- when it has been in contact with any body fluids,
- before using it for a new occupant.

8.3.3 Cleaning

! NOTICE!
Dirt, sand and seawater can damage the bearings and steel parts can rust if the surface is damaged.

- Only expose the wheelchair to sand and seawater for short periods and clean it after every trip to the beach.
- If the wheelchair is dirty, wipe off the dirt as soon as possible with a damp cloth and dry it carefully.

1. Remove any options fitted (only options which do not require tools).
2. Wipe down the individual parts using a cloth or soft brush, ordinary household cleaning agents (pH = 6 - 8) and warm water.
3. Rinse the parts with warm water
4. Thoroughly dry the parts with a dry cloth.

i Car polish and soft wax can be used on painted metal surfaces to remove abrasions and restore gloss.

Cleaning upholstery

For cleaning upholstery refer to the instructions on the labels of the seat, cushion and backrest cover.

-  If possible, always overlap hook and loop strips (the self-gripping parts) when washing, to minimize lint and thread build-up on hook strips and prevent damage to upholstery fabric by these.

1. Wipe down all generally accessible surfaces with a soft cloth and ordinary household disinfectant.
2. Allow the product to air-dry.

8.3.4 Cleaning the O2 holder



WARNING!

Risk of damage to the O2 cylinder

Injury or damage may occur if cleaning agents come in contact with the O2 regulator.
– The occupant and O2 cylinder **MUST** be out of the wheelchair when cleaning the O2 holder.

8.3.5 Washing

1. Remove all loose and removable covers and wash them in a washing machine according to the washing instructions for each cover.
2. Remove all padded parts such as seat cushions, armrests, headrest or neckrest with fixed padded parts, calf pads and so on and clean them separately.

 The padded parts can not be cleaned with a high-pressure cleaner or water jet.
3. Spray the wheelchair chassis with detergent, for example a car-cleaning agent with wax, and leave on to work.
4. Rinse the wheelchair chassis with a high-pressure cleaning or ordinary jet of water depending on how dirty the wheelchair is. Do not aim the jet towards bearings and draining holes. If the wheelchair chassis is washed in a machine the water must not be hotter than 60° C.

 Only use water and soft soap to clean the table.
5. Leave the wheelchair to dry in a drying cabinet. Remove parts where water has collected for example in end tubes, ferrules etc. If the wheelchair has been washed in a machine, blow-drying with compressed air is recommended.

Multi stretch polyurethane (PU) coated fabric

Lighter stains on the fabric may be neutralized with a soft damp cloth and some neutral detergent. To neutralize larger, more persistent stains, wipe the fabric with alcohol or turpentine substitutes, and wash with hot water and a neutral detergent

The fabric can be washed at temperatures up to 60° C. Normal detergents can be used.

-  All parts of the wheelchair with multi stretch polyurethane (PU) coated fabric upholstery, such as armrest pads, calf pads, headrest or neckrest, should be cleaned according to the instruction above.

8.3.6 Disinfection

The wheelchair may be disinfected by spraying or wiping with tested, approved disinfectants.

-  Spray a soft cleaning and disinfecting product (bactericidal and fungicide meeting the EN1040/ EN1276 / EN1650 standards) and follow the instructions given by the manufacturer.

9 Troubleshooting

9.1 Safety Information

Faults may arise as a result of daily use, adjustments or changing demands on the wheelchair. The table below shows how to identify and repair faults. Some of the actions listed must be carried out by a qualified technician. These are indicated. We recommend that all adjustments are carried out by a qualified technician.



CAUTION!

If you notice a fault with your wheelchair, e.g. a significant change in handling, stop using your wheelchair immediately and contact your provider.

9.2 Identifying and repairing faults

Fault	Possible cause	Action
The wheelchair does not travel in a straight line	Incorrect tyre pressure on one rear wheel	Correct tyre pressure, → 11.3 Tyres, page 62
	One or more spokes broken	Replace faulty spoke(s), → qualified technician
	Spokes tightened unevenly	Tighten loose spokes, → qualified technician
	Castor bearings are dirty or damaged	Clean the bearings or replace the castor, → qualified technician
The wheelchair tips backwards too easily	Rear wheels are mounted too far forwards	Mount the rear wheels further back, → qualified technician
	Back angle too large	Reduce the backrest angle, → qualified technician
	Seat angle too large	Mount the castor upper on the front fork, → qualified technician Select a smaller front fork, → qualified technician

The brakes are gripping poorly or asymmetrically	Incorrect tyre pressure in one or both rear tyres	Correct tyre pressure, → 11.3 Tyres, page 62
	Brake setting incorrect	Correct the brake setting, → qualified technician
Rolling resistance is very high	Tyre pressure in rear tyres is too low	Correct tyre pressure, → 11.3 Tyres, page 62
	Rear wheels not parallel	Ensure the rear wheels are parallel, → qualified technician
The castors wobble when moving fast	Too little tension in castor bearing block	Tighten the nut on the bearing block axle slightly, → qualified technician
	Castor has worn smooth	Change castor, → qualified technician
The castor is stiff or stuck	Bearings are dirty or faulty	Clean the bearings or replace the castor, → qualified technician
The wheelchair is very difficult to unfold	Backrest cover is too tight	Loosen the hook and loop strips of the backrest cover a little, → 3.5.2 Adjustable Backrest Cover, page 8

10 After use

10.1 Storage

- !** **NOTICE!**
Risk of damage to the product
- Do not store the product near heat sources.
 - Never store other items on top of the wheelchair.
 - Store the wheelchair indoors in a dry environment.
 - Refer to temperature limitation in chapter 11 Technical Data, page 60

After long-term storage (more than four months) the wheelchair must be inspected in accordance to chapter 8 Maintenance, page 52.

10.2 Disposal

Be environmentally responsible and recycle this product through your recycling facility at its end of life.

Disassemble the product and its components, so the different materials can be separated and recycled individually.

The disposal and recycling of used products and packaging must comply with the laws and regulations for waste handling in each country. Contact your local waste management company for information.

10.3 Reconditioning

This product is suitable for reuse. To recondition the product for a new occupant, carry out the following actions:

- Inspection
- Cleaning and disinfection
- Adaptation to the new operators (occupant and assistant)

For detailed information, see 8 Maintenance, page XX and the service manual for this product.

Make sure that the user manual is handed over with the product.

If any damage or malfunction is detected, do not reuse the product.

11 Technical data

11.1 Dimensions and weight

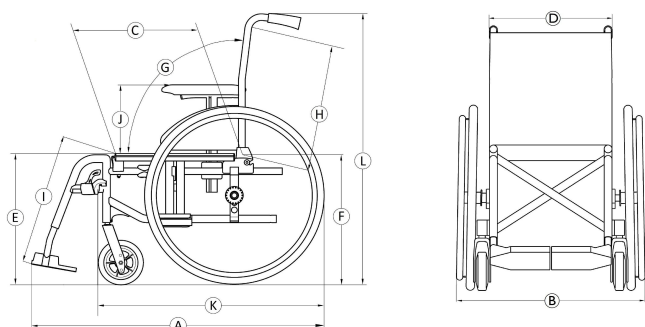

All dimension and weight specifications refer to a wide range of the wheelchair in a standard configuration. Dimension and weight (based on ISO 7176-1/5/7) may alter according to different configurations. In some configurations, the wheelchair exceeds the recommended dimensions for a wheelchair.

! NOTICE!

- In some configurations, the overall dimensions of the wheelchair when it is ready for use exceeds the recommended maximum values and the access to emergency escape routes may be not possible.
- In some configurations, the wheelchair exceeds the recommended specifications for traveling by train in the EU.

(*) the maximum load of the wheelchair is the total of the maximum occupant mass and the maximum mass of any other items intended to be carried by the wheelchair.

The maximum occupant mass is the maximum load of the wheelchair without additional load.

e.g. : for a wheelchair with a back pack of 10kg:

Maximum Occupant Mass = Maximum Load of the wheelchair – 10 kg

	maximum load of the wheelchair (*)	Action 4NG: 125kg Spirea 4NG: 135kg Action 4NG HD / Spirea 4NG HD: 160kg
Ⓐ	Overall length with leg rest	990 – 1180 mm
Ⓑ	Overall width	605 – 840 mm
	Folded length	980 – 1180 mm
	Folded width	305 – 325 mm
	Folded height	780 – 1060 mm
	Total mass	from 15 – 21,5 kg
	Mass of the heaviest part	8,3 – 13,5 kg

	Static stability	Downhill: 0° – 21° Uphill: 0° – 7° Sideways: 0° – 18,5°
	Seat plane angle	0° – 8°
Ⓒ	Effective seat depth	360 – 530 mm
Ⓓ	Effective seat width	385 – 620 mm, in increments of 25 mm
Ⓔ	Seat surface height at front edge	365 – 515 mm, in increments of 25 mm
Ⓕ	Seat surface height at rear edge	365 – 515 mm, in increments of 25 mm
Ⓖ	Backrest angle	Range: -6° / +30°, Fixed: 90°, Step less adj.: 90° (-6°/+15°) Step less adj.: 90° (-15°/+15°) Recliner: 90° (0°/+30°) (steps 10°)
Ⓗ	Backrest height	350 – 550 mm
Ⓘ	Footrest to seat distance	200 – 565 mm, in increments of 10 mm
	Leg to seat surface angle	0° – 90°
⓫	Armrest to seat height	Range: 170 – 295 mm "T" arm: 200 – 280 mm Comfort: 170 – 295 mm
	Front location of armrest structure	250 – 350 mm
	Hand rim diameter	390 – 535 mm
	Horizontal location of axle	-75 / + 52,5 mm
	Minimum turning radius	790 mm
	Stowage width	260 – 305 mm
	Stowage height	605 – 880 mm
	Stowage length	1050 – 1150 mm
Ⓚ	Overall length without leg rests	390 – 535 mm
Ⓛ	Overall height	795 – 1050 mm
	Pivot width	1480 – 1630 mm
	Maximum slope angle brake	7°
	Oxygen cylinders recommended dimensions	Diameter max: 111 mm Length min/max: 198 – 645 mm Weight min/max: 1,3 – 3,6 kg

11.2 Maximum Weight of Removable Parts

Part	Maximum weight:
Leg rest angle adjustable with calf pad and footrest	3,2 kg
Armrest	2,0 kg
Rear wheel 600 mm (24") solid with handrim and spoke guard	2,5 kg
Headrest / Neckrest / Cheek support	1,4 kg
Trunk support	0,8 kg
Backrest cushion	2,0 kg
Seat cushion	1,9 kg
Table tray	3,9 kg

11.3 Tyres

The ideal pressure depends on the tyre type:

Tyre	Max. pressure		
	bar	kPa	psi
Pneumatic profiled tyre: 515 mm (20"); 560 mm (22"); 610 mm (24")	4.5	450	65
Pneumatic low profile tyre: 560 mm (22"); 610 mm (24")	7.5	750	110
Solid tyre: 305 mm (12"); 405 mm (16"); 515 mm (20"); 560 mm (22"); 610 mm (24")	-	-	-
Solid tyre: 150 mm (6"); 140 mm (5" 1/2); 125 mm (5"); 200 mm (8")	-	-	-
Pneumatic tyre: 200 mm (8")	2.5	250	36

 The compatibility of the tyres listed above depends on the configuration and/or model of your wheelchair.

 In case of a tyre puncture consult a suitable workshop (e.g. bike repair shop, bicycle dealer ...) to have the tube replaced by a skilled person.

 The size of the tyre is mentioned on the sidewall of the tyre. The change of appropriate tyres must be carried out by a qualified technician.





CAUTION!

The tyre pressure has to be equal in both wheels to avoid a less driving comfort, to keep the brakes efficiency and an easy propelling of the wheelchair.

11.4 Materials

Frame/backrest tubes	Aluminum, Steel
Upholstery (seat and backrest)	Foam PUR, Fabric Nylon and Polyester
Push handles	PVC
Plastic parts like brake handles, clothes guards, foot plates, armpads and parts of most options	Thermoplastic (e.g. PA, PP, ABS and PUR) according to marking on the parts
Folding mechanism / vertical brace / clamping parts / castor forks	Aluminum, Steel
Screws, washers and nuts	Steel

 All materials used are protected against corrosion. We use only REACH compliant materials and components.

 Theft and metal detection systems: in seldom cases the materials used in the wheelchair may activate theft and metal detection systems.

11.5 Environmental conditions

	Storage and transportation	Operation
Temperature	-20 °C to 40 °C	-5 °C to 40 °C
Relative humidity	20 % to 90 % at 30 °C, not condensing	
Atmospheric pressure	800 hPa to 1060 hPa	

 Be aware that when a wheelchair has been stored under low temperatures, it must be adjusted to chapter [8 Maintenance](#).

**United Kingdom:**

Invacare Limited
Pencoed Technology Park, Pencoed
Bridgend CF35 5AQ
Tel: (44) (0) 1656 776 200
Tel: (44) (0) 1656 776 200
uk@invacare.com
www.invacare.co.uk

Ireland:

Invacare Ireland Ltd,
Unit 5 Seatown Business Campus
Seatown Road, Swords, County Dublin
EirCode: K67 K271 — Ireland
Tel : (353) 1 810 7084
Fax: (353) 1 810 7085
ordersireland@invacare.com

Australia:

Invacare Australia Pty. Ltd.
Unit 18/12 Stanton Road,
Seven Hills, NSW 2147,
Australia
Phone: 1800 460 460
Fax: 1800 814 367
orders@invacare.com.au

New Zealand:

Invacare New Zealand Ltd
4 Westfield Place, Mt Wellington
1060
New Zealand
Phone: 0800 468 222
Fax: 0800 807 788
sales@invacare.co.nz

Asia:

Invacare Asia Ltd.
Unit 18/12 Stanton Road,
Seven Hills, NSW 2147
Australia
Phone: (61) (02) 8839 5333
Fax: (61) (02) 8839 5343
asiasales@invacare.com

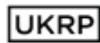

Invacare UK Operations Limited
Unit 4, Pencoed Technology Park,
Pencoed
Bridgend CF35 5AQ
UK



Invacare France Operations SAS
Route de St Roch
F-37230 Fondettes
France

1608637-I

18-02-2025

**Making Life's Experiences Possible®****Yes, you can.**